

# YASKAWA

# GA800 DRIVE

## INSTALLATION & PRIMARY OPERATION

### AC DRIVE FOR INDUSTRIAL APPLICATIONS

#### CATALOG CODE:

GA80Uxxxxxxxx

#### CAPACITIES:

Three-Phase 200 V class: 1 to 150 HP

Three-Phase 400 V class: 1 to 600 HP

PDF

[yaskawa.com/TOEPC71061737](http://yaskawa.com/TOEPC71061737)



Simplify Drive Installation  
Get DriveWizard® Mobile



<https://www.yaskawa.com/dwm>

DOCUMENT NUMBER: TOEPC71061737

---

**This Page Intentionally Blank**

# Table of Contents

---

1. General Information . . . . .	6
2. Safety . . . . .	6
Explanation of Signal Words . . . . .	6
General Safety Instructions . . . . .	6
Exclusion of Liability . . . . .	8
3. Cybersecurity . . . . .	8
4. Receiving . . . . .	8
How to Read the Catalog Code . . . . .	9
Rated Output Current . . . . .	10
5. Common Drive Specifications . . . . .	11
Area of Use . . . . .	15
Surrounding Air Temperature . . . . .	15
6. Mechanical Installation . . . . .	15
Drive Exterior and Mounting Dimensions (IP20/UL Open Type) . . . . .	15
Moving the Drive . . . . .	18
Using the Hanging Brackets to Move the Drive . . . . .	19
Installation Position and Clearances . . . . .	19
Install Single Drive . . . . .	19
Install Drives Side-by-Side . . . . .	20
Removing/Reattaching Covers . . . . .	20
Removing/Reattaching the Cover Using Procedure A . . . . .	21
Removing/Reattaching the Cover Using Procedure B . . . . .	22
7. Electrical Installation . . . . .	25
Standard Connection Diagram . . . . .	25
Standard Connection Diagram for Three-Phase Drives . . . . .	27
Main Circuit Terminal Functions . . . . .	29
Motor and Main Circuit Connections . . . . .	29
Main Circuit Terminal Block Wiring . . . . .	30
Wire Selection . . . . .	30
Main Circuit Terminal Block Wiring Procedure . . . . .	40
Wire the Main Circuit Terminal Block with Procedure A . . . . .	41
Wire the Main Circuit Terminal Block with Procedure B . . . . .	43

8. Keypad: Names and Functions .....	45
Keypad Mode and Menu Displays .....	48
9. LED Status Ring .....	50
10. Drive Start-Up .....	51
Setup Wizard .....	51
Change Parameter Setting Values .....	52
Disable the Initial Setup Screen .....	54
Control Circuit Terminal Block Functions .....	54
Input Terminals .....	55
Output Terminals .....	56
External Power Supply Input Terminals .....	57
Serial Communication Terminals .....	57
Control Circuit Terminal Configuration .....	57
Control Circuit Wire Gauges and Tightening Torques .....	58
Wiring the Control Circuit Terminal .....	59
Switches and Jumpers on the Terminal Board .....	61
Control I/O Connections .....	62
Pulse Train Output .....	62
Set Sinking Mode/Sourcing Mode .....	63
Set Input Signals for MFAI Terminals A1 to A3 .....	64
Set MFAI Terminal A3 to PTC Input .....	65
Set Output Signals for MFAO Terminals FM, AM .....	65
Switch ON Termination Resistor for MEMOBUS/Modbus Communications .....	66
11. Drive Control, Duty Modes, and Programming .....	66
Control Method Selection .....	66
Drive Duty Modes .....	67
Auto-Tuning .....	67
Drive Parameters .....	68
12. UL Standards .....	72
Area of Use .....	73
Surrounding Air Temperature .....	73
Main Circuit Wire Gauges and Tightening Torques .....	73
Closed-Loop Crimp Terminals .....	73
Factory-Recommended Branch Circuit Protection for UL Listing .....	76
Three-Phase 200 V Class .....	77
Three-Phase 400 V Class .....	78
UL Standards Compliance for DC Power Supply Input .....	79
Low Voltage Wiring for Control Circuit Terminals .....	80
Drive Motor Overload and Overheat Protection .....	80
E2-01: Motor Rated Current (FLA) .....	80
E5-03: Motor Rated Current (FLA) .....	81
E9-06: Motor Rated Current (FLA) .....	81
L1-01: Motor Overload (oL1) Protection .....	81
L1-02: Motor Overload Protection Time .....	84
L1-03: Motor Thermistor oH Alarm Select .....	85
L1-04: Motor Thermistor oH Fault Select .....	85

13. European Standards .....	86
EU Declaration of Conformity .....	86
CE Low Voltage Directive Compliance .....	86
Area of Use .....	86
Guarding Against Debris .....	87
Electrical Installation .....	87
Main Circuit Wire Gauges and Tightening Torques .....	88
Connect a Fuse to the Input Side (Primary Side) .....	97
CE Standards Compliance for DC Power Supply Input .....	98
14. China RoHS Compliance .....	101
Information on Hazardous Substances in This Product .....	101
15. 对应中国RoHS指令 .....	101
本产品中含有有害物质的信息 .....	102
16. Safe Disable Input .....	102
Safe Disable Specifications .....	102
Notes .....	103
Using the Safe Disable Function .....	104
Safe Disable Circuit .....	104
Enabling and Disabling the Drive Output (“Safe Torque Off”) .....	104
Safe Disable Monitor Output Function and Keypad Display .....	105
Validating the Safe Disable Function .....	105
17. Seismic Standards .....	106
18. Australian Standard .....	106
19. Disposal Instructions .....	106
WEEE Directive .....	107
20. Maintenance .....	107
21. Troubleshooting .....	107
Fault .....	108
Minor Faults/Alarms .....	117
Parameter Setting Errors .....	122
Auto-Tuning Errors .....	124
Backup Function Operating Mode Display and Errors .....	126
Revision History .....	128

# 1 General Information

The products and specifications given in this manual and the manual contents can change without notice to make the product and manual better.

Be sure to always use the latest version of this manual. Use this manual to correctly install, wire, set, and operate this product.

Users can download additional manuals for this product from the Yaskawa documentation website printed on the back cover.

# 2 Safety

Read all safety precautions before you install, wire, or operate the drive.

## ◆ Explanation of Signal Words

- ⚠ DANGER** *This signal word identifies a hazard that will cause serious injury or death if you do not prevent it.*
- ⚠ WARNING** *This signal word identifies a hazard that can cause death or serious injuries if you do not prevent it.*
- ⚠ CAUTION** *This signal word identifies a hazardous situation, which, if not avoided, can cause minor or moderate injury.*
- NOTICE** *This signal word identifies a property damage message that is not related to personal injury.*

## ◆ General Safety Instructions

Yaskawa Electric manufactures and supplies electronic components for a variety of industrial applications. The selection and application of Yaskawa products is the responsibility of the designer of the equipment or the customer who assembles the final product. Yaskawa is not responsible for how our products are incorporated into the final system design. In all cases, Yaskawa products should not be incorporated into a product or design as the exclusive or sole safety control function. All control functions are designed to dynamically detect failures and operate safely without exception. All products that are designed to incorporate parts manufactured by Yaskawa must be provided to the end user and include proper warnings and instructions regarding their safe use and operation. All warnings from Yaskawa must be promptly issued to the end user. Yaskawa offers warranties only for the quality of our products, in compliance with standards and specifications that are described in the manual. Yaskawa does not offer other warranties, either explicit or implied. Injuries, property damage, and lost business opportunities caused by improper storage or handling and negligence oversight on the part of your company or your customers will void Yaskawa's warranty for the product.

### Note:

- Read this manual carefully when mounting, operating, and repairing AC drives.
- Obey all warnings, cautions, and notices.
- Approved personnel must perform all work.
- Install the drive according to this manual and local codes.

**⚠ DANGER** *Electrical Shock Hazard. Do not examine, connect, or disconnect wiring on an energized drive. Before servicing, disconnect all power to the equipment and wait for the time specified on the warning label at a minimum. The internal capacitor stays charged after the drive is de-energized. The charge indicator LED extinguishes when the DC bus voltage decreases below 50 Vdc. When all indicators are OFF, remove the covers before measuring for dangerous voltages to make sure that the drive is safe. If you do work on the drive when it is energized, it will cause serious injury or death from electrical shock.*

**⚠ WARNING** *Fire Hazard. Do not connect main power supply wiring to drive motor terminals U/T1, V/T2, and W/T3. Connect main power supply wiring to main circuit input terminals R/L1, S/L2, and T/L3. Incorrect wiring can cause serious injury or death from fire.*

**⚠ WARNING** *Electrical Shock Hazard. Do not modify the drive body or drive circuitry. Modifications to drive body and circuitry can cause serious injury or death, will cause damage to the drive, and will void the warranty. Yaskawa is not responsible for modifications of the product made by the user.*

**⚠ WARNING** *Crush Hazard. Only approved personnel can operate a crane or hoist to move the drive. If unapproved personnel operate a crane or hoist, it can cause serious injury or death from falling equipment.*

**⚠ WARNING** *Electrical Shock Hazard. Only let approved personnel install, wire, maintain, examine, replace parts, and repair the drive. If personnel are not approved, it can cause serious injury or death.*

- ⚠ WARNING** *Electrical Shock Hazard. Always ground the motor-side grounding terminal. If you do not ground the equipment correctly, it can cause serious injury or death if you touch the motor case.*
- ⚠ WARNING** *Electrical Shock Hazard. Do not wear loose clothing or jewelry when you do work on the drive. Tighten loose clothing and remove all metal objects, for example watches or rings. Loose clothing can catch on the drive and jewelry can conduct electricity and cause serious injury or death.*
- ⚠ WARNING** *Sudden Movement Hazard. Before you do Auto-Tuning, remove all personnel and objects from the area around the drive, motor, and load. The drive and motor can start suddenly during Auto-Tuning and cause serious injury or death.*
- ⚠ WARNING** *Sudden Movement Hazard. Remove all personnel and objects from the area around the drive, motor, and machine and attach covers, couplings, shaft keys, and machine loads before you energize the drive. If personnel are too close or if there are missing parts, it can cause serious injury or death.*
- ⚠ WARNING** *Damage to Equipment. Do not apply incorrect voltage to the main circuit of the drive. Operate the drive in the specified range of the input voltage on the drive nameplate. Voltages that are higher than the permitted nameplate tolerance can cause damage to the drive.*
- ⚠ WARNING** *Fire Hazard. Do not put flammable or combustible materials on top of the drive and do not install the drive near flammable or combustible materials. Attach the drive to metal or other noncombustible material. Flammable and combustible materials can start a fire and cause serious injury or death.*
- ⚠ WARNING** *Fire Hazard. Tighten all terminal screws to the correct tightening torque. Connections that are too loose or too tight can cause incorrect operation and damage to the drive. Incorrect connections can also cause death or serious injury from fire.*
- ⚠ WARNING** *Fire Hazard. Tighten screws at an angle in the specified range shown in this manual. If you tighten the screws at an angle not in the specified range, you can have loose connections that can cause damage to the terminal block or start a fire and cause serious injury or death.*
- ⚠ WARNING** *Crush Hazard. Use a crane or hoist to move large drives when necessary. If you try to move a large drive without a crane or hoist, it can cause serious injury or death.*
- ⚠ WARNING** *Electrical Shock Hazard. Do not cause a short circuit on the drive output circuit. A short circuit on the output can cause serious injury or death.*
- ⚠ WARNING** *Electrical Shock Hazard. When there is a DC component in the protective earthing conductor, the drive can cause a residual current. When a residual current operated protective or monitoring device prevents direct or indirect contact, always use a type B Ground Fault Circuit Interrupter (GFCI) as specified by IEC/EN 60755. If you do not use the correct GFCI, it can cause serious injury or death.*
- ⚠ WARNING** *Electrical Shock Hazard. Ground the neutral point on the power supply of drive models 2xxxB/C and 4xxxB/C to comply with the EMC Directive before you turn on the EMC filter. If you turn ON the EMC filter, but you do not ground the neutral point, it can cause serious injury or death.*
- ⚠ WARNING** *Crush Hazard. Test the system to make sure that the drive operates safely after you wire the drive and set parameters. If you do not test the system, it can cause damage to equipment or serious injury or death.*
- ⚠ WARNING** *Electrical Shock Hazard. After the drive blows a fuse or trips a GFCI, do not immediately energize the drive or operate peripheral devices. Wait for the time specified on the warning label at a minimum and make sure that all indicators are OFF. Then check the wiring and peripheral device ratings to find the cause of the problem. If you do not know the cause of the problem, contact Yaskawa before you energize the drive or peripheral devices. If you do not fix the problem before you operate the drive or peripheral devices, it can cause serious injury or death.*
- ⚠ WARNING** *Crush Hazard. Only approved personnel can operate a crane or hoist to move the drive. If unapproved personnel operate a crane or hoist, it can cause serious injury or death from falling equipment.*
- ⚠ WARNING** *Fire Hazard. Install sufficient branch circuit short circuit protection as specified by applicable codes and this manual. The drive is suitable for circuits that supply not more than 100,000 RMS symmetrical amperes, 240 Vac maximum (200 V Class), 480 Vac maximum (400 V Class). Incorrect branch circuit short circuit protection can cause serious injury or death.*
- ⚠ CAUTION** *Crush Hazard. Tighten terminal cover screws and hold the case safely when you move the drive. If the drive or covers fall, it can cause moderate injury.*
- ⚠ CAUTION** *Burn Hazard. Do not touch a hot drive heatsink. De-energize the drive, wait for a minimum of 15 minutes, then make sure that the heatsink is cool before you replace the cooling fans. If you touch a hot drive heatsink, it can burn you.*
- NOTICE** *Damage to Equipment. When you touch the drive and circuit boards, make sure that you observe correct electrostatic discharge (ESD) procedures. If you do not follow procedures, it can cause ESD damage to the drive circuitry.*
- NOTICE** *Do not break the electrical connection between the drive and the motor when the drive is outputting voltage. Incorrect equipment sequencing can cause damage to the drive.*
- NOTICE** *Damage to Equipment. Do not do a withstand voltage test or use a megohmmeter or megger insulation tester on the drive. These tests can cause damage to the drive.*

**NOTICE** Do not operate a drive or connected equipment that has damaged or missing parts. You can cause damage to the drive and connected equipment.

**NOTICE** Install branch circuit protection, for example fuses or ground fault circuit interrupters (GFCIs) as specified in the drive instructions. If you do not install these components, it can cause damage to the drive and connected equipment.

**NOTICE** *Damage to Equipment.* Before you connect a dynamic braking option to the drive, make sure that qualified personnel read and obey the Braking Unit and Braking Resistor Unit Installation Manual (TOBPC72060001). If you do not read and obey the manual or if personnel are not qualified, it can cause damage to the drive and braking circuit.

**NOTICE** Make sure that all connections are correct after you install the drive and connect peripheral devices. Incorrect connections can cause damage to the drive.

**NOTICE** Do not connect phase-advancing capacitors, LC/RC noise filters, or leakage breakers (GFCI) to the motor circuit. If you connect these devices to the output circuits, it can cause damage to the drive and connected equipment.

**NOTICE** Use an inverter-duty motor or vector-duty motor with reinforced insulation and windings applicable for use with an AC drive. If the motor does not have the correct insulation, it can cause a short circuit or ground fault from insulation deterioration.

**Note:**

Do not use unshielded wire for control wiring. Use shielded, twisted-pair wires and ground the shield to the ground terminal of the drive. Unshielded wire can cause electrical interference and unsatisfactory system performance.

---

#### ◆ Exclusion of Liability

- This product is not designed and manufactured for use in life-support machines or systems.
- Contact a Yaskawa representative or your Yaskawa sales representative if you are considering the application of this product for special purposes, such as machines or systems used for passenger cars, medicine, airplanes and aerospace, nuclear power, electric power, or undersea relaying.

**⚠ WARNING** *Injury to Personnel.* When you use this product in applications where its failure could cause the loss of human life, a serious accident, or physical injury, you must install applicable safety devices. If you do not correctly install safety devices, it can cause serious injury or death.

## 3 Cybersecurity

This product is designed to connect and communicate information and data through a network interface. It is the sole responsibility of the customer to provide and continuously guarantee a secure connection between the product and the customer's network or if applicable, any other network. The customer must establish and maintain the appropriate measures (such as, but not limited to, the installation of firewalls, the application of authentication measures, the encryption of data, the installation of antivirus programs, etc.) to protect the product, the network, its system and the interface against all types of security breaches, unauthorized access, interference, intrusion, leakage and/or theft of data or information. Yaskawa and its affiliates are not responsible for damages and/or losses related to such security breaches, any unauthorized access, interference, intrusion, leakage and/or theft of data or information.

## 4 Receiving

1. Inspect the product for damage and missing parts. Immediately contact the shipping company if the drive is damaged. The Yaskawa warranty does not cover damage from shipping.
2. Check the catalog code in the "C/C" section of the drive nameplate to make sure that you received the correct model.
3. If you did not receive the correct drive or if your drive does not operate correctly, contact your supplier.
4. Check drive and motor compatibility for systems with more than one drive.

**NOTICE** *Damage to Equipment.* Do not install or use damaged parts or damaged motors into the drive system.



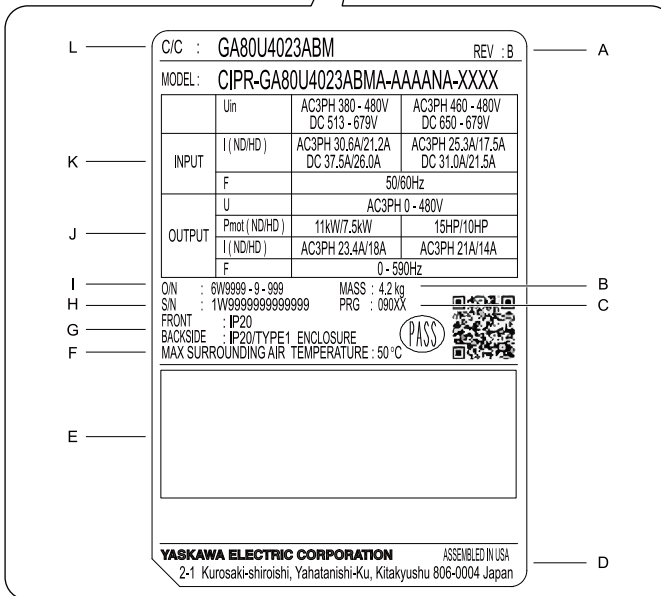
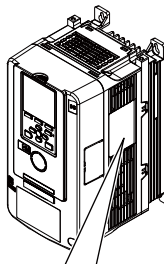

- A - Hardware revision
- B - Weight
- C - Drive software version
- D - The address of the head office of Yaskawa Electric Corporation
- E - Accreditation standards
- F - Surrounding air temperature
- G - Protection design
- H - Serial number
- I - Lot number
- J - Output specifications
- K - Input specifications
- L - Catalog code

Figure 4.1 Nameplate Example

### ◆ How to Read the Catalog Code

Use the information in Figure 4.2 and Table 4.1 to read the drive catalog codes.

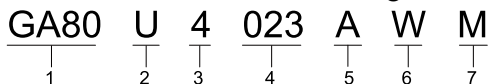

Figure 4.2 Drive Catalog Code

Table 4.1 Catalog Code Details

No.	Description
1	GA800 Series
2	Region code • U: Americas
3	Input power supply voltage • 2: Three-Phase AC 240 V • 4: Three-Phase AC 480 V
4	Rated output current <b>Note:</b> Refer to the rated output current list for more information.

No.	Description
5	EMC noise filter <ul style="list-style-type: none"> <li>A: No built-in EMC filter</li> <li>B: Internal category C3 EMC filter</li> </ul>
6	Protection design <ul style="list-style-type: none"> <li>B: IP20/UL Open Type</li> <li>W: IP55/UL Type 12 Heatsink External Mounting</li> </ul>
7	Environmental specification <ul style="list-style-type: none"> <li>A: Standard</li> <li>M: Resistant to dust/humidity</li> </ul>

## ■ Rated Output Current

Table 4.2 and Table 4.3 give the rated output current values.

**Note:**

- These output current values are applicable for drives that operate at standard specifications.
- Derate the output current in applications that:
  - Increase the carrier frequency
  - Have high ambient temperature
  - Install drives side-by-side.
- Use C6-01 [Normal / Heavy Duty Selection] to select Normal Duty rating (ND) or Heavy Duty rating (HD).

**Table 4.2 Rated Output Current: Three-Phase 200 V Class**

Model	Heavy Duty Rating (HD) [C6-01 = 0]		Normal Duty Rating (ND) [C6-01 = 1] (Default)	
	Maximum Applicable Motor Output kW (HP)	Rated Output Current A	Maximum Applicable Motor Output kW (HP)	Rated Output Current A
2004	0.55 (0.75)	3.5	0.75 (1)	4.2
2006	0.75 (1)	5	1.1 (1.5)	6
2008	1.1 (1.5)	6.9	1.5 (2)	8
2010	1.5 (2)	8	2.2 (3)	9.6
2012	2.2 (3)	11	3 (4)	12.2
2018	3 (4)	14	3.7 (5)	17.5
2021	3.7 (5)	17.5	5.5 (7.5)	21
2030	5.5 (7.5)	25	7.5 (10)	30
2042	7.5 (10)	33	11 (15)	42
2056	11 (15)	47	15 (20)	56
2070	15 (20)	60	18.5 (25)	70
2082	18.5 (25)	75	22 (30)	82
2110	22 (30)	88	30 (40)	110
2138	30 (40)	115	37 (50)	138
2169	37 (50)	145	45 (60)	169
2211	45 (60)	180	55 (75)	211
2257	55 (75)	215	75 (100)	257
2313	75 (100)	283	90 (125)	313
2360	90 (125)	346	110 (150)	360
2415	110 (150)	415	110 (150)	415

Table 4.3 Rated Output Current: Three-Phase 400 V Class

Model	Heavy Duty Rating (HD) [C6-01 = 0]		Normal Duty Rating (ND) [C6-01 = 1] (Default)	
	Maximum Applicable Motor Output kW (HP)	Rated Output Current A	Maximum Applicable Motor Output kW (HP)	Rated Output Current A
4002	0.55 (0.75)	1.8	0.75 (1)	2.1
4004	1.1 (1.5)	3.4	1.5 (2)	4.1
4005	1.5 (2)	4.8	2.2 (3)	5.4
4007	2.2 (3)	5.5	3 (4)	7.1
4009	3.0 (4)	7.2	3.7 (5)	8.9
4012	3.7 (5)	9.2	5.5 (7.5)	11.9
4018	5.5 (7.5)	14.8	7.5 (10)	17.5
4023	7.5 (10)	18	11 (15)	23.4
4031	11 (15)	24	15 (20)	31
4038	15 (20)	31	18.5 (25)	38
4044	18.5 (25)	39	22 (30)	44
4060	22 (30)	45	30 (40)	59.6
4075	30 (40)	60	37 (50)	74.9
4089	37 (50)	75	45 (60)	89.2
4103	45 (60)	91	55 (75)	103
4140	55 (75)	112	75 (100)	140
4168	75 (100)	150	90 (125)	168
4208	90 (125)	180	110 (150)	208
4250	110 (150)	216	150 (200)	250
4302	150 (200)	260	185 (250)	302
4371	185 (250)	304	220 (300)	371
4414	220 (300)	371	260 (350)	414
4477	260 (350)	414	300 (400)	477
4568	300 (400)	477	335 (450)	568
4605	335 (450)	605	370 (500)	675
4720	370 (500)	605	450 (600)	720

## 5 Common Drive Specifications

**Note:**

- To get the OLV, CLV, and AOLV specifications, do Rotational Auto-Tuning.
- To get the longest product life, install the drive in an environment that meets the necessary specifications.

**Table 5.1 Control Characteristics**

Item	Specification
Control Methods	<ul style="list-style-type: none"> <li>• V/f Control</li> <li>• V/f Control with Encoder</li> <li>• Open Loop Vector</li> <li>• Closed Loop Vector</li> <li>• Advanced Open Loop Vector</li> <li>• PM Open Loop Vector</li> <li>• PM Advanced Open Loop Vector</li> <li>• PM Closed Loop Vector</li> <li>• EZ Vector Control</li> </ul>
Carrier Frequency	<ul style="list-style-type: none"> <li>• Models 2004 to 2138, and 4002 HD: 8 kHz without derating the drive capacity. ND: 2 kHz without derating the drive capacity. Derate the drive capacity to use values to 15 kHz maximum.</li> <li>• Models 2169 to 2415, and 4140 to 4414 HD: 5 kHz without derating the drive capacity. ND: 2 kHz without derating the drive capacity. Derate the drive capacity to use values to 10 kHz maximum.</li> <li>• Models 4477 to 4720 HD: 2 kHz without derating the drive capacity. ND: 2 kHz without derating the drive capacity. Derate the drive capacity to use values to 5 kHz maximum.</li> </ul>
Maximum Output Voltage	<ul style="list-style-type: none"> <li>• 200 V Class: Three-phase 200 V to 240 V</li> <li>• 400 V Class: Three-phase 380 V to 480 V</li> </ul> <p><b>Note:</b> The maximum output voltage is proportional to the input voltage.</p>
Frequency Control Range	<ul style="list-style-type: none"> <li>• AOLV and EZOLV: 0.01 Hz to 120 Hz</li> <li>• CL-V/f, CLV, AOLV/PM, and CLV/PM: 0.01 Hz to 400 Hz</li> <li>• V/f, OLV, and OLV/PM: 0.01 Hz to 590 Hz</li> </ul>
Frequency Accuracy (Temperature Fluctuation)	<p>Digital inputs: <math>\pm 0.01\%</math> of the maximum output frequency (-10 °C to +40 °C (14 °F to 104 °F)) Analog inputs: In <math>\pm 0.1\%</math> of the maximum output frequency (25 °C <math>\pm</math> 10 °C (77 °F <math>\pm</math> 18 °F))</p>
Frequency Setting Resolution	<p>Digital inputs: 0.01 Hz Analog inputs: 1/2048 of the maximum output frequency (11-bit signed)</p>
Output Frequency Resolution	0.001 Hz
Frequency Setting Signal	<p>Main speed frequency reference: -10 VDC to +10 VDC (20 k<math>\Omega</math>), 0 VDC to 10 VDC (20 k<math>\Omega</math>), 4 mA to 20 mA (250 <math>\Omega</math>), 0 mA to 20 mA (250 <math>\Omega</math>) Main speed reference: Pulse train input (maximum 32 kHz)</p>
Starting Torque	<ul style="list-style-type: none"> <li>• V/f: 150%/3 Hz</li> <li>• CL-V/f: 150%/3 Hz</li> <li>• OLV: 200%/0.3 Hz</li> <li>• CLV: 200%/0 min<sup>-1</sup> (r/min)</li> <li>• AOLV: 200%/0.3 Hz</li> <li>• OLV/PM: 100%/5% speed</li> <li>• AOLV/PM: 200%/0 min<sup>-1</sup> (r/min)</li> <li>• CLV/PM: 200%/0 min<sup>-1</sup> (r/min)</li> <li>• EZOLV: 100%/1% speed</li> </ul> <p><b>Note:</b></p> <ul style="list-style-type: none"> <li>• Correctly select the drive and motor capacity for this starting torque in these control methods: –OLV –CLV –AOLV –AOLV/PM –CLV/PM</li> <li>• Set <math>n8-57 = 1</math> [HFI Overlap Selection = Enabled] for this starting torque in AOLV/PM. When you use a non-Yaskawa PM motor, do Rotational Auto-Tuning.</li> </ul>

Item	Specification
Speed Control Range	<ul style="list-style-type: none"> <li>V/f: 1:40</li> <li>CL-V/f: 1:40</li> <li>OLV: 1:200</li> <li>CLV: 1:1500</li> <li>AOLV: 1:200</li> <li>OLV/PM: 1:20</li> <li>AOLV/PM: 1:100</li> <li>CLV/PM: 1:1500</li> <li>EZOLV: 1:100</li> </ul> <p><b>Note:</b></p> <ul style="list-style-type: none"> <li>Set n8-57 = 1 [HFI Overlap Selection = Enabled] for this Speed Control Range in AOLV/PM. When you use a non-Yaskawa PM motor, do Rotational Auto-Tuning.</li> <li>Speed control range of 1:100 for AOLV/PM is Instantaneous operation range. Correctly select the drive and motor capacity for continuous operation.</li> </ul>
Zero Speed Control	<p>Possible in these control methods:</p> <ul style="list-style-type: none"> <li>CLV</li> <li>AOLV/PM</li> <li>CLV/PM</li> </ul>
Torque Limits	<p>You can use parameter settings for different limits in four quadrants in these control methods:</p> <ul style="list-style-type: none"> <li>OLV</li> <li>CLV</li> <li>AOLV</li> <li>AOLV/PM</li> <li>CLV/PM</li> <li>EZOLV</li> </ul>
Acceleration and Deceleration Times	<p>0.0 s to 6000.0 s</p> <p>The drive can set four pairs of different acceleration and deceleration times.</p>
Braking Torque	<p>Approximately 20%</p> <p>Approximately 125% with a dynamic braking option</p> <ul style="list-style-type: none"> <li>Short-time average deceleration torque                             <ul style="list-style-type: none"> <li>Motor output 0.4/0.75 kW: over 100%</li> <li>Motor output 1.5 kW: over 50%</li> <li>Motor output 2.2 kW and larger: over 20%, Overexcitation Braking/High Slip Braking allow for approximately 40%</li> </ul> </li> <li>Continuous regenerative torque: Approximately 20%. Dynamic braking option allows for approximately 125%, 10%ED, 10 s</li> </ul> <p><b>⚠ WARNING</b> Set L3-04 = 0 [Stall Prevention during Decel = Disabled] when you operate the drive with:</p> <ul style="list-style-type: none"> <li>a regenerative converter</li> <li>regenerative unit</li> <li>braking unit</li> <li>braking resistor</li> <li>braking resistor unit.</li> </ul> <p><i>If you set the parameter incorrectly, the drive can decelerate for too long and cause serious injury or death.</i></p> <p><b>Note:</b></p> <ul style="list-style-type: none"> <li>Models 2004 to 2138 and 4002 to 4168 have a built-in braking transistor.</li> <li>Short-time average deceleration torque refers to the necessary torque to decelerate the motor (uncoupled from the load) from the rated speed to zero. Motor characteristics can change the actual specifications.</li> <li>Motor characteristics change the continuous regenerative torque and short-time average deceleration torque for motors 2.2 kW and larger.</li> </ul>
V/f Characteristics	Select from 15 pre-defined V/f patterns, or a user-set V/f pattern.
Main Control Functions	Torque Control, Droop Control, Speed/Torque Control Switching, Feed Forward Control, Zero Servo Function, Restart After Momentary Power Loss, Speed Search, Overtorque/Undertorque Detection, Torque Limit, 17 Step Speed (maximum), Accel/Decel Switch, S-curve Acceleration/Deceleration, 3-wire Sequence, Auto-Tuning (Rotational and Stationary), Dwell Function, Cooling Fan ON/OFF Switch, Slip Compensation, Torque Compensation, Frequency Jump, Upper/Lower Limits for Frequency Reference, DC Injection Braking at Start and Stop, Overexcitation Braking, High Slip Braking, PID Control (with Sleep Function), Energy Saving Control, MEMOBUS/Modbus Communication (RS-485 max, 115.2 kbps), Auto Restart, Application Presets, DriveWorksEZ (customized functions), Removable Terminal Block with Parameter Backup Function, Online Tuning, KEB, Overexcitation Deceleration, Inertia (ASR) Tuning, Overvoltage Suppression, High Frequency Injection

Table 5.2 Protection Functions

Item	Specification
Motor Protection	Electronic thermal overload protection
Momentary Overcurrent Protection	Drive stops when the output current is more than 200% of the HD output current.
Overload Protection	<p>Drive stops when the output current is more than these overload tolerances:</p> <ul style="list-style-type: none"> <li>HD: 150% of the rated output current for 60 seconds The permitted frequency of overload is one time each 10 minutes.</li> <li>ND: 110% of the rated output current for 60 seconds The permitted frequency of overload is one time each 10 minutes.</li> </ul> <p><b>Note:</b></p> <ul style="list-style-type: none"> <li>If output frequency &lt; 6 Hz, the drive can trigger the overload protection function when the output current is in the overload tolerance range.</li> <li>Derating can be necessary for applications that start and stop frequently.</li> </ul>

## 5 Common Drive Specifications

Item	Specification
Overvoltage Protection	200 V Class: Stops when the DC bus voltage is more than approximately 410 V 400 V Class: Stops when the DC bus voltage is more than approximately 820 V
Undervoltage Protection	200 V Class: Stops when the DC bus voltage decreases to less than approximately 190 V 400 V Class: Stops when the DC bus voltage decreases to less than approximately 380 V
Momentary Power Loss Ride-thru	Stops when power loss is longer than 15 ms. Continues operation if power loss is shorter than 2 s (depending on parameter settings). <b>Note:</b> <ul style="list-style-type: none"> <li>The stop time can be shorter depending on the load and motor speed.</li> <li>Drive capacity will change the continuous operation time. A Momentary Power Loss Recovery Unit is necessary to continue operation through a 2 s power loss on models 2004 to 2056 and 4002 to 4031.</li> </ul>
Heatsink Overheat Protection	The drive stops when the thermistor detects an IGBT temperature more than approximately 100 °C (212 °F). The trip temperature level is different for different drive models.
Braking Resistor Overheat Protection	Overheat detection for braking resistor (optional ERF-type, 3% ED)
Stall Prevention	Stall prevention is available during acceleration, deceleration, and during run.
Ground Fault Protection	Electronic circuit protection <b>Note:</b> <p>This protection detects ground faults during run. The drive will not provide protection when:</p> <ul style="list-style-type: none"> <li>There is a low-resistance ground fault for the motor cable or terminal block</li> <li>There is a ground fault and you energize the drive</li> </ul>
DC Bus Charge LED	Charge LED illuminates when DC bus voltage is more than 50 V.
Braking Transistor	Models 2004 to 2138 and 4002 to 4168 have a braking transistor.
DC Link Choke	Models 2110 to 2415 and 4060 to 4720 have a DC link choke.

**Table 5.3 Environment**

Item	Specification
Area of Use	Indoors
Power Supply	Overvoltage Category III Permitted frequency fluctuation: ±5% Permitted voltage fluctuation: -15% to +10% 200 V Class: <ul style="list-style-type: none"> <li>Three-phase AC power supply 200 V to 240 V at 50/60 Hz</li> <li>DC power supply 270 V to 340 V</li> </ul> 400 V Class: <ul style="list-style-type: none"> <li>Three-phase AC power supply 380 V to 480 V at 50/60 Hz</li> <li>DC power supply 513 V to 679 V</li> </ul>
Surrounding Air Temperature	IP20/UL Open Type/Heatsink External Mounting: -10 °C to +50 °C (14 °F to 122 °F) IP20/UL Type 1: -10 °C to +40 °C (14 °F to 104 °F) IP55/UL Type 12 Heatsink External Mounting; front side: -10 °C to +50 °C (14 °F to 122 °F) IP55/UL Type 12 Heatsink External Mounting; back side: -10 °C to +40 °C (14 °F to 104 °F) <ul style="list-style-type: none"> <li>When you install the drive in an enclosure, use a cooling fan or air conditioner to keep the internal air temperature in the permitted range.</li> <li>Do not let the drive freeze.</li> <li>You can use IP20/UL Open Type drives at a maximum of 60 °C (140 °F) when you derate the output current.</li> <li>You can use IP20/UL Type 1 drives at a maximum of 50 °C (122 °F) when you derate the output current.</li> </ul>
Humidity	95% RH or less Do not let condensation form on the drive.
Storage Temperature	-20 °C to +70 °C (-4 °F to +158 °F) (short-term temperature during transportation)
Surrounding Area	Pollution degree 2 or less Install the drive in an area without: <ul style="list-style-type: none"> <li>Oil mist, corrosive or flammable gas, or dust</li> <li>Metal powder, oil, water, or other unwanted materials</li> <li>Radioactive materials or flammable materials, including wood</li> <li>Harmful gas or fluids</li> <li>Salt</li> <li>Direct sunlight</li> </ul>

Item	Specification
Altitude	1000 m (3281 ft) maximum <b>Note:</b> Derate the output current by 1% for each 100 m (328 ft) to install the drive in altitudes between 1000 m to 4000 m (3281 ft to 13123 ft). It is not necessary to derate the rated voltage in these conditions: • When you install the drive at 2000 m (6562 ft) or lower • When you install the drive between 2000 m to 4000 m (6562 ft to 13123 ft) and ground the neutral point on the power supply. Contact Yaskawa or your nearest sales representative if you will not ground the neutral point.
Vibration	<ul style="list-style-type: none"> <li>10 Hz to 20 Hz: 1 G (9.8 m/s<sup>2</sup>, 32.15 ft/s<sup>2</sup>)</li> <li>20 Hz to 55 Hz:                2004 to 2211, 4002 to 4168: 0.6 G (5.9 m/s<sup>2</sup>, 19.36 ft/s<sup>2</sup>)                2257 to 2415, 4208 to 4720: 0.2 G (2.0 m/s<sup>2</sup>, 6.56 ft/s<sup>2</sup>)</li> </ul>
Installation Orientation	Install the drive vertically for sufficient airflow to cool the drive.

Table 5.4 Standard

Item	Specification
Harmonized Standard	<ul style="list-style-type: none"> <li>UL 508C</li> <li>EN61800-3</li> <li>IEC/EN61800-5-1</li> <li>Two Safe Disable inputs and one EDM output according to EN ISO 13849-1:2015 (PL e (Cat.III)), IEC/EN61508 SIL3</li> </ul>
Enclosure Protection Design	IP20/UL Open Type IP20/UL Type 1 IP55/UL Type 12 Heatsink External Mounting <b>Note:</b> To change an IP20/UL Open Type drive to an IP20/UL Type 1 drive, install a UL Type 1 kit.

## ◆ Area of Use

Install this product in a location with Overvoltage Category III and pollution degree 2 or less as specified in UL 508C.

## ■ Surrounding Air Temperature

Keep the ambient temperature in these ranges according to the enclosure type.

- IP20/UL Type 1: -10 °C to +40 °C (14 °F to 104 °F)
- IP20/UL Open Type/Heatsink External Mounting: -10 °C to +50 °C (14 °F to 122 °F)
- IP55/UL Type 12 Heatsink External Mounting; front side: -10 °C to +50 °C (14 °F to 122 °F)
- IP55/UL Type 12 Heatsink External Mounting; back side: -10 °C to +40 °C (14 °F to 104 °F)

# 6 Mechanical Installation

This section gives information about the standard environment for correct installation.

## ◆ Drive Exterior and Mounting Dimensions (IP20/UL Open Type)

For additional IP20/UL Open Type drive dimension information, refer to the Technical Reference manual (document number SIEPC71061737).

For IP55/UL Type 12 Heatsink External Mounting dimension information, refer to the Installation Manual (document number TOEPC71061779) and the Quick Setup Procedures (document numbers TOEPC71061780 and TOEPC71061781).

For dimensions and installation instructions for other external heatsink installations, refer to the External Heatsink Installation Kit Instruction Manual (document number TOEPC72060003).

For product weights, refer to the drive nameplate.

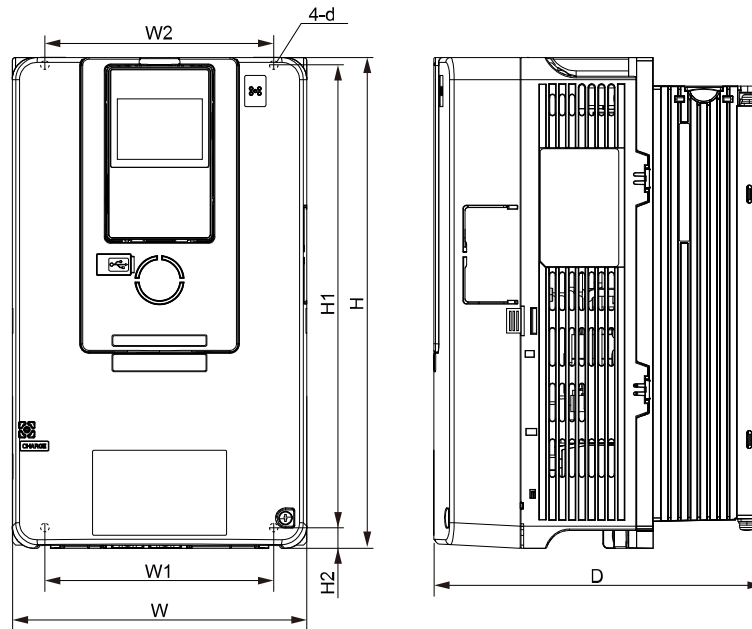

**Table 6.1 IP20/UL Open Type Exterior and Mounting Dimensions for Models 2004 to 2082**

Model	Dimensions mm (in)							
	W	H	D	W1	W2	H1	H2	d
2004 - 2012	140 (5.51)	260 (10.24)	176 (6.93)	102 (4.02)	102 (4.02)	248 (9.76)	6 (0.24)	M5
2018 - 2042	140 (5.51)	260 (10.24)	211 (8.31)	102 (4.02)	102 (4.02)	248 (9.76)	6 (0.24)	M5
2056	180 (7.09)	300 (11.81)	202 (7.95)	140 (5.51)	140 (5.51)	284 (11.18)	8 (0.32)	M5
2070 - 2082	220 (8.66)	350 (13.78)	227 (8.94)	192 (7.56)	192 (7.56)	335 (13.19)	8 (0.32)	M6

**Table 6.2 IP20/UL Open Type Exterior and Mounting Dimensions for Models 4002 to 4060**

Model	Dimensions mm (in)							
	W	H	D	W1	W2	H1	H2	d
4002 - 4005	140 (5.51)	260 (10.24)	176 (6.93)	102 (4.02)	102 (4.02)	248 (9.76)	6 (0.24)	M5
4007 - 4023	140 (5.51)	260 (10.24)	211 (8.31)	102 (4.02)	102 (4.02)	248 (9.76)	6 (0.24)	M5
4031 - 4038	180 (7.09)	300 (11.81)	202 (7.95)	140 (5.51)	140 (5.51)	284 (11.18)	8 (0.32)	M5
4044	220 (8.66)	350 (13.78)	227 (8.94)	192 (7.56)	192 (7.56)	335 (13.19)	8 (0.32)	M6
4060	220 (8.66)	350 (13.78)	246 (9.69)	192 (7.56)	192 (7.56)	335 (13.19)	8 (0.32)	M6



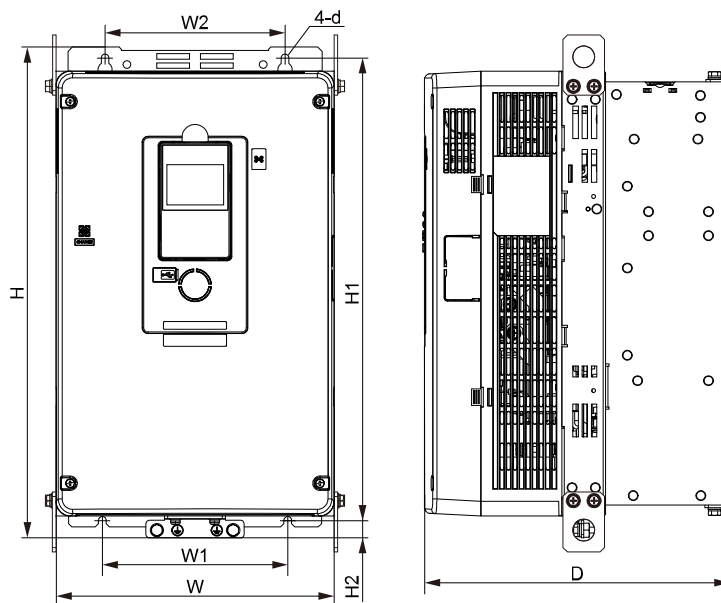
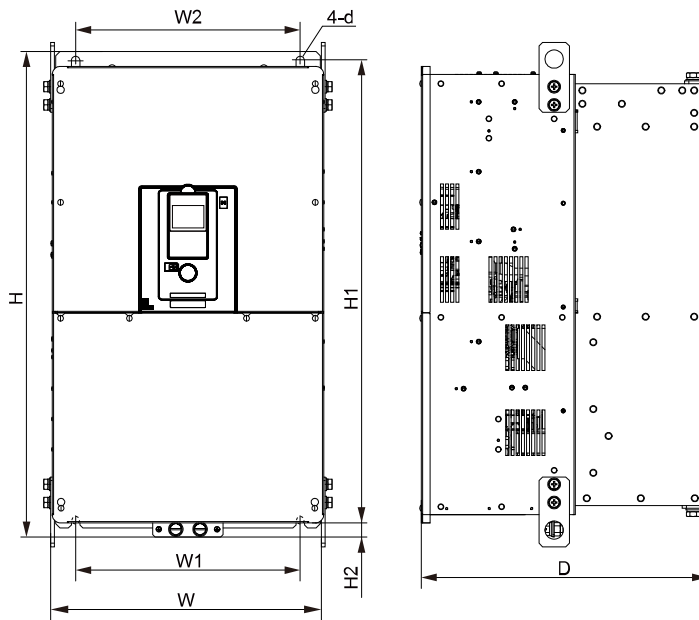

Table 6.3 IP20/UL Open Type Exterior and Mounting Dimensions for Models 2110 to 2211

Model	Dimensions mm (in)							
	W	H	D	W1	W2	H1	H2	d
2110	240 (9.45)	400 (15.75)	280 (11.02)	195 (7.68)	186 (7.32)	375 (14.76)	17.5 (0.69)	M6
2138	255 (10.04)	450 (17.72)	280 (11.02)	170 (6.69)	165 (6.50)	424 (16.69)	16 (0.63)	M6
2169 - 2211	264 (10.39)	543 (21.38)	335 (13.19)	190 (7.48)	182 (7.17)	516 (20.31)	17.5 (0.69)	M8

Table 6.4 IP20/UL Open Type Exterior and Mounting Dimensions for Models 4075 to 4168

Model	Dimensions mm (in)							
	W	H	D	W1	W2	H1	H2	d
4075	240 (9.45)	400 (15.75)	280 (11.02)	195 (7.68)	186 (7.32)	375 (14.76)	17.5 (0.69)	M6
4089 - 4103	255 (10.04)	450 (17.72)	280 (11.02)	170 (6.69)	165 (6.50)	424 (16.69)	16 (0.63)	M6
4140 - 4168	264 (10.39)	543 (21.38)	335 (13.19)	190 (7.48)	182 (7.17)	516 (20.31)	17.5 (0.69)	M8



**Table 6.5 IP20/UL Open Type Exterior and Mounting Dimensions for Models 2257 to 2415**

Model	Dimensions mm (in)							
	W	H	D	W1	W2	H1	H2	d
2257 - 2313	312 (12.28)	700 (27.56)	420 (16.54)	218 (8.58)	218 (8.58)	659 (25.94)	28 (1.10)	M10
2360 - 2415	440 (17.32)	800 (31.50)	472 (18.58)	370 (14.57)	370 (14.57)	757 (29.80)	28 (1.10)	M12

**Table 6.6 IP20/UL Open Type Exterior and Mounting Dimensions for Models 4208 to 4720**

Model	Dimensions mm (in)							
	W	H	D	W1	W2	H1	H2	d
4208 - 4302	312 (12.28)	700 (27.56)	420 (16.54)	218 (8.58)	218 (8.58)	659 (25.94)	28 (1.10)	M10
4371 - 4414	440 (17.32)	800 (31.50)	472 (18.58)	370 (14.57)	370 (14.57)	757 (29.80)	28 (1.10)	M12
4477 - 4720	510 (20.08)	1136 (44.72)	480 (18.90)	450 (17.72)	450 (17.72)	1093 (43.03)	25.5 (1.00)	M12

### ◆ Moving the Drive

Obey local laws and regulations when moving and installing this product.

**CAUTION** *Crush Hazard. Tighten terminal cover screws and hold the case safely when you move the drive. If the drive or covers fall, it can cause moderate injury.*

Drive Weight	Persons Necessary to Move the Drive
< 15 kg (33 lb)	1
≥ 15 kg (33 lb)	2 + using appropriate lifting equipment

Refer to the Technical Reference for information about how to use suspension systems, wires, or hanging metal brackets to move the drive.

## ◆ Using the Hanging Brackets to Move the Drive

Use the hanging brackets attached to the drive to temporarily lift the drive when you install the drive to a control panel or wall or when you replace the drive. Do not let the drive stay vertically or horizontally suspended or move the drive over a long distance while it is suspended.

Before you install the drive, make sure that you read these precautions:

**⚠ WARNING** *Crush Hazard. Before you hang the drive vertically, use screws to correctly attach the drive front cover and other drive components. If you do not secure the front cover, it can fall and cause minor injury.*

**⚠ WARNING** *Crush Hazard. When you use a crane or hoist to lift the drive during installation or removal, prevent more than 1.96 m/s<sup>2</sup> (0.2 G) vibration or impact. Too much vibration or impact can cause serious injury or death from falling equipment.*

**⚠ WARNING** *Crush Hazard. When you lift the drive during installation or removal, do not try to turn the drive over and do not ignore the hanging drive. If you move a hanging drive too much or if you ignore it, the drive can fall and cause serious injury or death.*

**⚠ WARNING** *Crush Hazard. When you install the drive, do not hold the front cover. Install the drive with holding the heatsink. If you hold the front cover, the cover will come off and the drive will fall, then it can cause injury.*

## ◆ Installation Position and Clearances

Install the drive vertically for sufficient airflow to cool the drive.

### Note:

Contact Yaskawa or a Yaskawa representative for more information about installing drive models on their side.

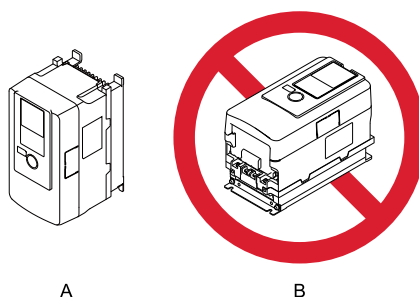

A - Vertical installation

B - Horizontal installation

Figure 6.1 Installation Orientation

## ■ Install Single Drive

Use the clearances specified in [Figure 6.2](#) to install the drive. Make sure that there is sufficient space for wiring and airflow to cool the drive.

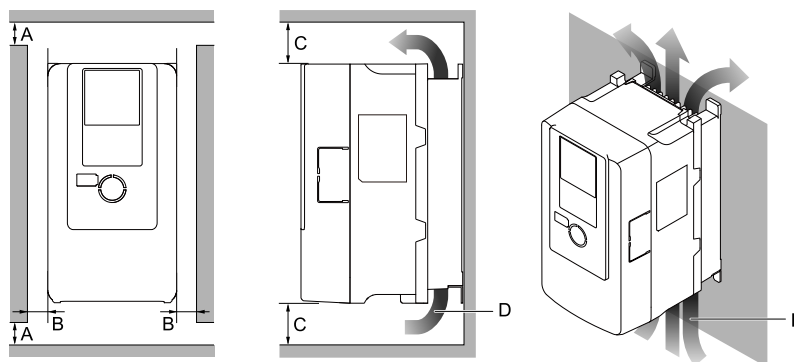

A - 50 mm (2 in) minimum

B - 30 mm (1.2 in) minimum on each side

C - 120 mm (4.7 in) minimum above and below

D - Airflow direction

Figure 6.2 Installation Clearances for One Drive

## ■ Install Drives Side-by-Side

You can install drive models 2004xB to 2082xB and 4002xB to 4044xB side-by-side.

When you install other drives side-by-side, make sure that you keep the necessary clearances between the drives for single drive installation.

To install these models side-by-side, make sure that there is sufficient space as shown in [Figure 6.3](#). Set *L8-35 = 1* [*Installation Method Selection = Side-by-Side Mounting*].

Derate the output current to align with the ambient temperature.

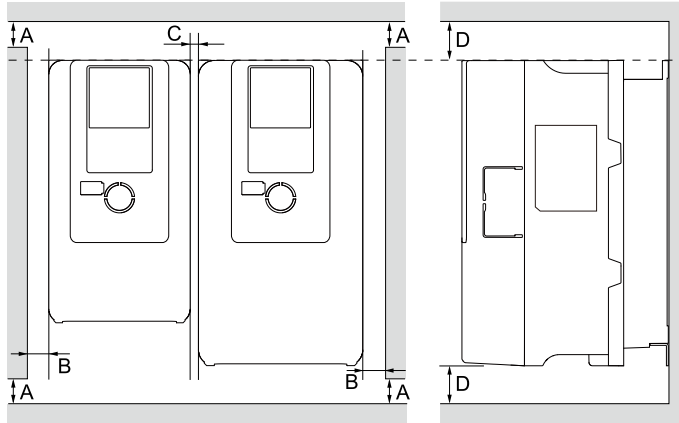

A - 50 mm (2 in) minimum

B - 30 mm (1.2 in) minimum on each side

C - 2 mm (0.08 in) minimum between each drive

D - 120 mm (4.7 in) minimum above and below

**Figure 6.3 Installation Clearances for More than One Drive (Side-by-Side)**

### Note:

- When you do side-by-side installations of drives that have different dimensions, align the tops of the drives. This will make it easier to replace the cooling fans.
- Remove the top protective covers of all drives when you mount IP20/UL Type 1 drives side-by-side.

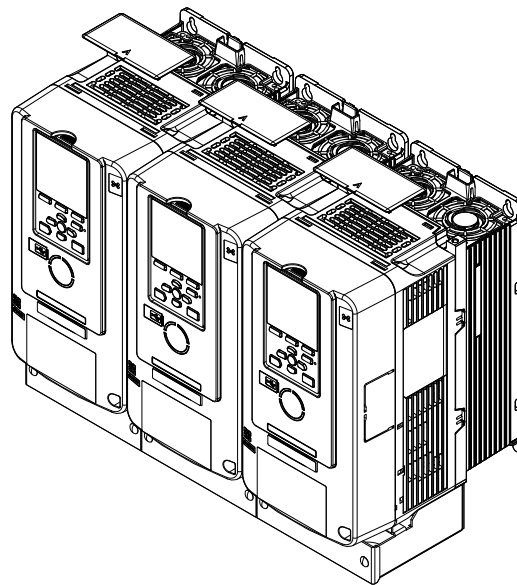

**Figure 6.4 IP20/UL Type 1 Drives Installed Side-by-Side**

## ◆ Removing/Reattaching Covers

This section gives information about how to remove and reattach the front cover and terminal cover for wiring and inspection.

Different drive models have different procedures to remove and reattach the covers. Refer to [Table 6.7](#) for more information.

**Table 6.7 Procedures to Remove Covers by Drive Model**

Model	Procedure	Ref.
2004 - 2211 4002 - 4168	Procedure A	21
2257 - 2415 4208 - 4720	Procedure B	22

## ■ Removing/Reattaching the Cover Using Procedure A

**⚠ DANGER** *Electrical Shock Hazard. Do not examine, connect, or disconnect wiring on an energized drive. Before servicing, disconnect all power to the equipment and wait for the time specified on the warning label at a minimum. The internal capacitor stays charged after the drive is de-energized. The charge indicator LED extinguishes when the DC bus voltage decreases below 50 Vdc. When all indicators are OFF, remove the covers before measuring for dangerous voltages to make sure that the drive is safe. If you do work on the drive when it is energized, it will cause serious injury or death from electrical shock.*

### Remove the Front Cover

1. Remove the keypad and the keypad connector, then insert the end of the keypad connector that has the tab into the keypad connector holder on the front cover.

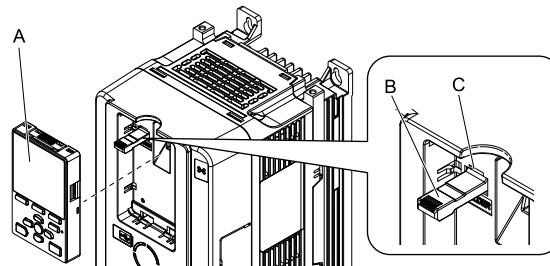

A - Keypad  
B - Keypad connector

C - Holder

**Figure 6.5 Remove the Keypad and Keypad Connector**

2. Loosen the front cover screws.

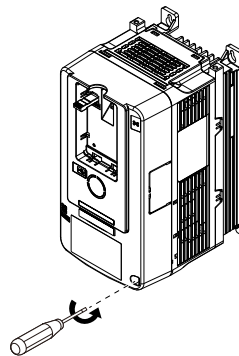

**Figure 6.6 Loosen the Front Cover Screws**

3. Push on the tab in the side of the front cover then pull the front cover forward to remove it from the drive.

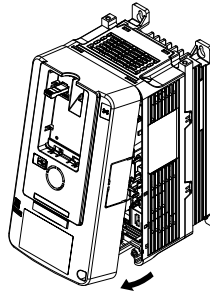

Figure 6.7 Remove the Front Cover

### Install the Front Cover

1. Wire the drive and other peripheral devices.
2. Reverse the steps to reattach the cover.

**Note:**

- Wire the grounding terminals first, main circuit terminals next, and control circuit terminals last.
- Make sure that you do not pinch wires or signal lines between the front cover and the drive before you reattach the cover.
- Tighten the screws to a tightening torque of 0.98 N·m to 1.33 N·m (8.67 lbf·in to 11.77 lbf·in).

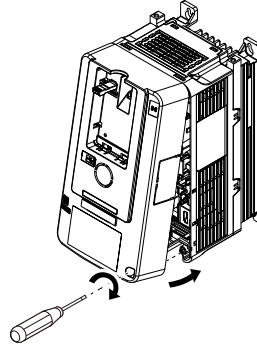

Figure 6.8 Install the Front Cover

3. Reattach the keypad to the original position.

### ■ Removing/Reattaching the Cover Using Procedure B

**⚠ DANGER** *Electrical Shock Hazard. Do not examine, connect, or disconnect wiring on an energized drive. Before servicing, disconnect all power to the equipment and wait for the time specified on the warning label at a minimum. The internal capacitor stays charged after the drive is de-energized. The charge indicator LED extinguishes when the DC bus voltage decreases below 50 Vdc. When all indicators are OFF, remove the covers before measuring for dangerous voltages to make sure that the drive is safe. If you do work on the drive when it is energized, it will cause serious injury or death from electrical shock.*

### Remove the Front Cover

1. Remove the terminal cover, keypad, and keypad connector, then insert the end of the keypad connector that has the tab into the keypad connector holder on the front cover.

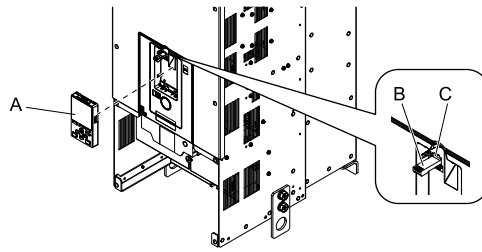

A - Keypad  
B - Keypad connector

C - Connector holder

Figure 6.9 Remove the Terminal Cover, Keypad, and Keypad Connector

2. Loosen the front cover screws.

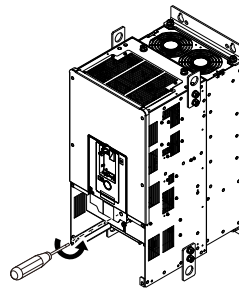
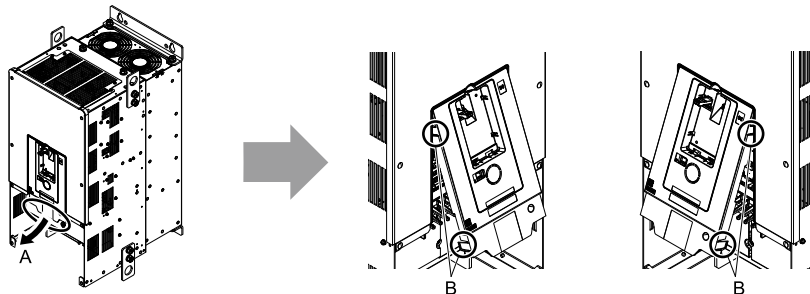

Figure 6.10 Loosen the Front Cover Screws

3. Push on the four tabs found on each side of the front cover, then pull the front cover forward to remove it from the drive.



A - Pull forward to remove the front cover.

B - Unhook the tabs found on the sides of the front cover.

Figure 6.11 Pull Forward to Remove the Front Cover

4. Remove the front cover from the drive.

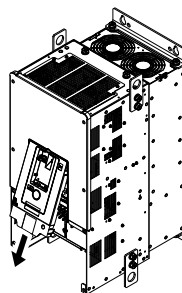

Figure 6.12 Remove the Front Cover

### Reattach the Front Cover

Wire the drive and other peripheral devices then reattach the front cover.

**Note:**

Wire the grounding terminals first, main circuit terminals next, and control circuit terminals last.

1. Move the front cover to connect the hooks at the top of the front cover to the drive.

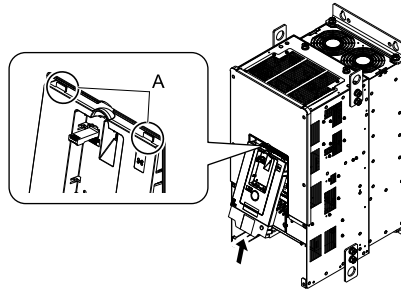

**A - Hooks**

**Figure 6.13 Reattach the Front Cover**

2. Move the front cover until it clicks into position while pushing on the hooks on the left and right sides of the front cover.

**Note:**

Make sure that you do not pinch wires or signal lines between the front cover and the drive before you reattach the cover.

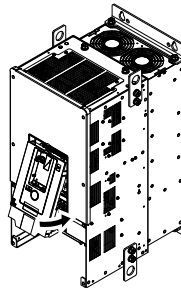

**Figure 6.14 Reattach the Front Cover**

3. Reattach the keypad to the original position.

### Remove the Terminal Cover

1. Loosen the screws on the terminal cover, then pull down on the cover.

**CAUTION** *Crush Hazard. Loosen the cover screws. Do not fully remove them. If you fully remove the cover screws, the terminal cover can fall and cause moderate injury.*

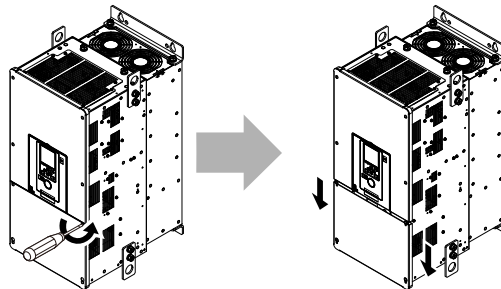

**Figure 6.15 Loosen the Terminal Cover Mounting Screws**



- Pull the terminal cover away from the drive.

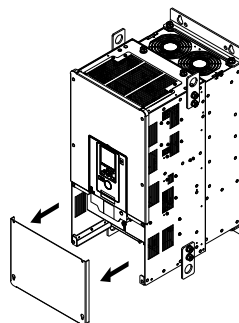

Figure 6.16 Remove the Terminal Cover

### Reattach the Terminal Cover

Wire the drive and other peripheral devices then reattach the terminal cover.

**Note:**

- Wire the grounding terminals first, main circuit terminals next, and control circuit terminals last.
- Make sure that you do not pinch wires or signal lines between the wiring cover and the drive before you reattach the cover.
- Tighten the screws to a tightening torque of 0.98 N·m to 1.33 N·m (8.67 lbf·in to 11.77 lbf·in).

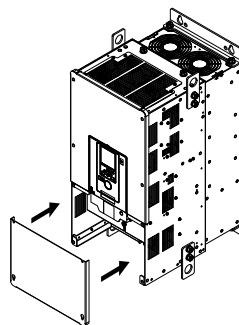

Figure 6.17 Reattach the Terminal Cover

## 7 Electrical Installation

**⚠ DANGER** *Electrical Shock Hazard. Do not examine, connect, or disconnect wiring on an energized drive. Before servicing, disconnect all power to the equipment and wait for the time specified on the warning label at a minimum. The internal capacitor stays charged after the drive is de-energized. The charge indicator LED extinguishes when the DC bus voltage decreases below 50 Vdc. When all indicators are OFF, remove the covers before measuring for dangerous voltages to make sure that the drive is safe. If you do work on the drive when it is energized, it will cause serious injury or death from electrical shock.*

**⚠ WARNING** *Electrical Shock Hazard. De-energize the drive and wait 5 minutes minimum until the Charge LED turns off. Remove the front cover and terminal cover to do work on wiring, circuit boards, and other parts. Use terminals for their correct function only. Incorrect wiring, incorrect ground connections, and incorrect repair of protective covers can cause death or serious injury.*

**⚠ WARNING** *Electrical Shock Hazard. Correctly ground the drive before you turn on the EMC filter switch. If you touch electrical equipment that is not grounded, it can cause serious injury or death.*

**⚠ WARNING** *Electrical Shock Hazard. Use the terminals for the drive only for their intended purpose. Refer to the technical manual for more information about the I/O terminals. Wiring and grounding incorrectly or modifying the cover may damage the equipment or cause injury.*

### ◆ Standard Connection Diagram

Wire the drive as specified by [Figure 7.1](#).

**⚠ WARNING** *Sudden Movement Hazard. Set the MFDI parameters before you close control circuit switches. Incorrect Run/Stop circuit sequence settings can cause serious injury or death from moving equipment.*

**⚠ WARNING** *Sudden Movement Hazard. Correctly wire the start/stop and safety circuits before you energize the drive. If you momentarily close a digital input terminal, it can start a drive that is programmed for 3-Wire control and cause serious injury or death from moving equipment.*

**⚠ WARNING** *Sudden Movement Hazard. When you use a 3-Wire sequence, set A1-03 = 3330 [Initialize Parameters = 3-Wire Initialization] and make sure that b1-17 = 0 [Run Command at Power Up = Disregard Existing RUN Command] (default). If you do not correctly set the drive parameters for 3-Wire operation before you energize the drive, the motor can suddenly rotate when you energize the drive.*

**⚠ WARNING** *Sudden Movement Hazard. Check the I/O signals and the external sequences for the drive before you set the Application Preset function. When you set the Application Preset function (A1-06 ≠ 0), it changes the I/O terminal functions for the drive and it can cause equipment to operate unusually. This can cause serious injury or death.*

**⚠ WARNING** *Fire Hazard. Install sufficient branch circuit short circuit protection as specified by applicable codes and this manual. The drive is suitable for circuits that supply not more than 100,000 RMS symmetrical amperes, 240 Vac maximum (200 V Class), 480 Vac maximum (400 V Class). Incorrect branch circuit short circuit protection can cause serious injury or death.*

**NOTICE** *When the input voltage is 440 V or higher or the wiring distance is longer than 100 m (328 ft), make sure that the motor insulation voltage is sufficient or use an inverter-duty motor or vector-duty motor with reinforced insulation. Motor winding and insulation failure can occur.*

**Note:**

Do not connect the AC control circuit ground to the drive enclosure. Failure to obey can cause incorrect control circuit operation.

## Standard Connection Diagram for Three-Phase Drives

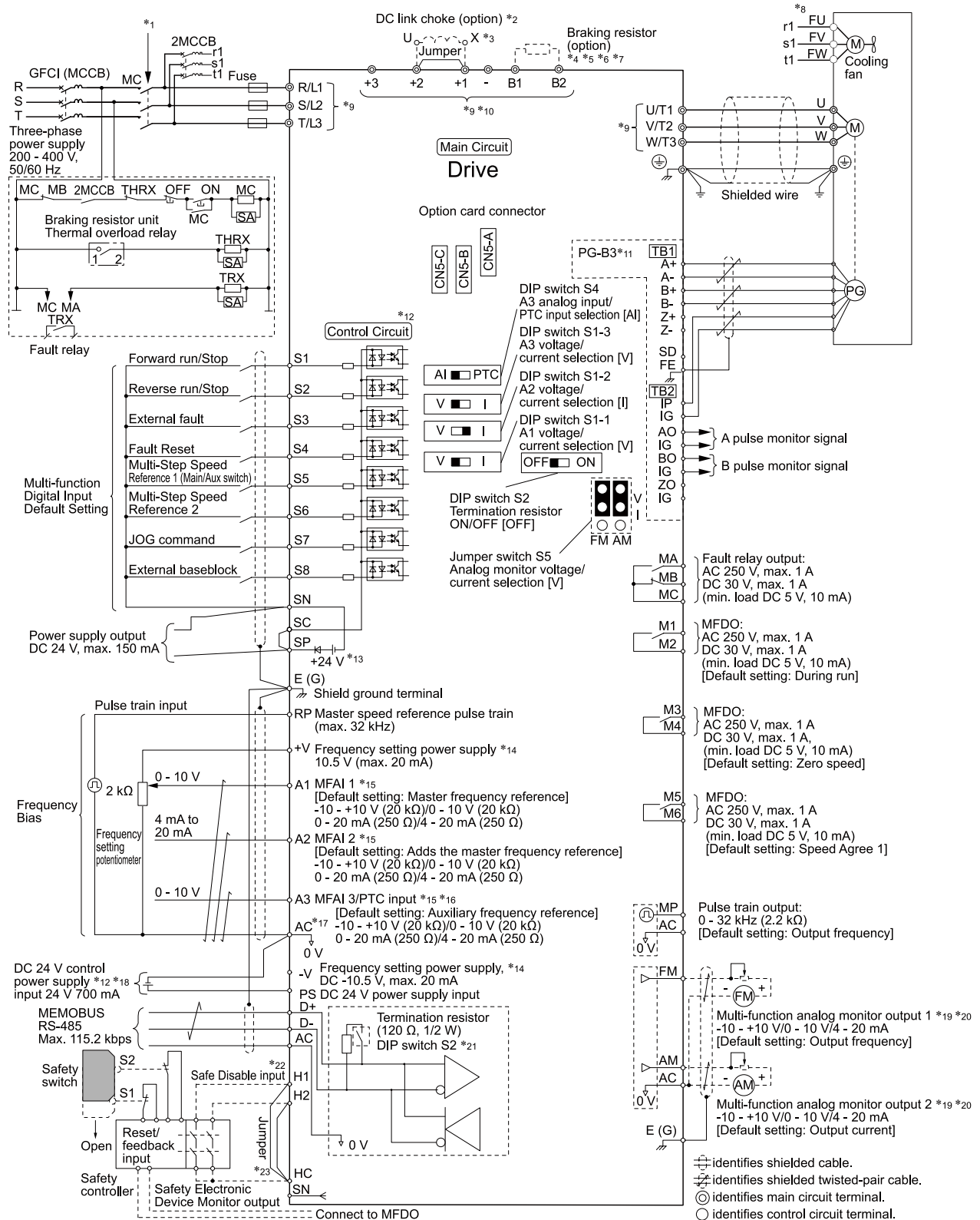

Figure 7.1 Standard Drive Connection Diagram

\*1 Set the wiring sequence to de-energize the drive with the fault relay output. If the drive outputs a fault during fault restart when you use the fault restart function, set L5-02 = 1 [Fault Contact at Restart Select = Always Active] to de-energize the drive. Be careful when you use a cut-off sequence. The default setting for L5-02 is 0 [Active Only when Not Restarting].

## 7 Electrical Installation

- \*2 When you install a DC link choke, you must remove the jumper between terminals +1 and +2. Ground the DC link choke (option) on the back of the mounting base. Remove all paint from the mounting surface of the control panel.
- \*3 Models 2110 to 2415 and 4060 to 4720 have a DC link choke.
- \*4 When you use a regenerative converter, regenerative unit, or braking unit, set  $L8-55 = 0$  [*Internal DB Transistor Protection = Disable*]. If  $L8-55 = 1$  [*Protection Enabled*], the drive will detect  $rF$  [*Braking Resistor Fault*].
- \*5 When you use a regenerative converter, regenerative unit, braking unit, braking resistor, or braking resistor unit, set  $L3-04 = 0$  [*Stall Prevention during Decel = Disabled*]. If  $L3-04 = 1$  [*General Purpose*], the drive could possibly not stop in the specified deceleration time.
- \*6 When you use an ERF-type braking resistor, set  $L8-01 = 1$  [*3% ERF DB Resistor Protection = Enabled*] and set a wiring sequence to de-energize the drive with the fault relay output.
- \*7 When you connect a braking unit (CDBR series) or a braking resistor unit (LKEB series) to drive models 2110, 2138, and 4103, make sure that you use wires that are in the range of the applicable gauges for the drive. A junction terminal is necessary to connect wires that are less than the applicable gauge to the drive. Contact Yaskawa or your nearest sales representative for more information about selection and installation of the junction terminal.
- \*8 Cooling fan wiring is not necessary for self-cooling motors.
- \*9 The number of terminals is different for different models.
  - Terminals R/L1, S/L2, T/L3, U/T1, V/T2, W/T3: There are two screws for each terminal block on models 4477 to 4720.
  - Terminal +3: Models 2169 to 2415 and 4208 to 4720 only. There are two screws for each terminal block on models 4477 to 4720.
  - Terminal +2: Models 2004 to 2082 and 4002 to 4044 only.
  - Terminals +1, -: There are two screws for each terminal block on models 2169, 2211, 4140, 4168, and 4477 to 4720.
  - Terminal B1, B2: Models 2004 to 2138 and 4002 to 4168 only.
- \*10 Connect peripheral options to terminals -, +1, +2, B1, and B2.
  - ⚠ WARNING** *Fire Hazard. Only connect factory-recommended devices or circuits to drive terminals B1, B2, -, +1, +2, and +3. Do not connect an AC power supply lines to these terminals. Incorrect wiring can cause damage to the drive and serious injury or death from fire.*
- \*11 Encoder circuit wiring (wiring to PG-B3 option) is not necessary for applications that do not use motor speed feedback.
- \*12 Connect a 24 V power supply to terminals PS-AC to operate the control circuit while the main circuit power supply is OFF.
- \*13 To set the MFDI power supply (Sinking/Sourcing Mode or internal/external power supply), install or remove a jumper between terminals SC-SP or SC-SN depending on the application.
  - NOTICE** *Damage to Equipment. Do not close the circuit between terminals SP-SN. If you close the circuits between terminals SC-SP and terminals SC-SN at the same time, it will cause damage to the drive.*
    - Sinking Mode, Internal power supply: Install the jumper to close the circuit between terminals SC-SP.
  - NOTICE** *Damage to Equipment. Do not close the circuit between terminals SC-SN. If you close the circuits between terminals SC-SP and terminals SC-SN at the same time, it will cause damage to the drive.*
    - Sourcing Mode, Internal power supply: Install the jumper to close the circuit between terminals SC-SN.
  - NOTICE** *Damage to Equipment. Do not close the circuit between terminals SC-SP. If you close the circuits between terminals SC-SP and terminals SC-SN at the same time, it will cause damage to the drive.*
    - External power supply: Remove the jumper from the MFDI terminals. It is not necessary to close the circuit between terminals SC-SP and terminals SC-SN.
- \*14 The maximum output current capacity for terminals +V and -V on the control circuit is 20 mA.
  - NOTICE** *Do not install a jumper between terminals +V, -V, and AC. A closed circuit between these terminals will cause damage to the drive.*
- \*15 DIP switches S1-1 to S1-3 set terminals A1 to A3 for voltage or current input. The default setting for S1-1 and S1-3 is voltage input ("V" side). The default setting for S1-2 is current input ("I" side).
- \*16 DIP switch S4 sets terminal A3 for analog or PTC input. Set DIP switch S1-3 to the "V" side, and set  $H3-05 = 0$  [*Terminal A3 Signal Level Select = 0 to 10V (Lower Limit at 0)*] to set terminal A3 for PTC input with DIP switch S4.
- \*17 Do not ground the control circuit terminals AC or connect them to the drive chassis.
  - NOTICE** *Do not ground the AC control circuit terminals and only connect the AC terminals according to the product instructions. If you connect the AC terminals incorrectly, it can cause damage to the drive.*
- \*18 Connect the positive lead from an external 24 Vdc power supply to terminal PS and the negative lead to terminal AC.
  - NOTICE** *Connect terminals PS and AC correctly for the 24 V power supply. If you connect the wires to the incorrect terminals, it will cause damage to the drive.*
- \*19 Use multi-function analog monitor outputs with analog frequency meters, ammeters, voltmeters, and wattmeters. Do not use monitor outputs with feedback-type signal devices.
- \*20 Jumper switch S5 sets terminal FM and AM for voltage or current output. The default setting for S5 is voltage output ("V" side).
- \*21 Set DIP switch S2 to "ON" to enable the termination resistor in the last drive in a MEMOBUS/Modbus network.
- \*22 Use only Sourcing Mode for Safe Disable input.
- \*23 Disconnect the wire jumpers between H1 and HC and H2 and HC to use the Safe Disable input.

## ◆ Main Circuit Terminal Functions

Refer to [Table 7.1](#) for the functions of drive main circuit terminals.

**Table 7.1 Main Circuit Terminal Functions**

Terminal	Name				Function	
	2004 - 2082	2110 - 2138	2169 - 2415	-		
Model	4002 - 4044	4060 - 4168	4208 - 4414	4477 - 4720		
R/L1	Main circuit power supply input				To connect a commercial power supply.	
S/L2						
T/L3						
U/T1	Drive output				To connect a motor.	
V/T2						
W/T3						
B1	Braking resistor connection		-		To connect a braking resistor or braking resistor unit.	
B2						
+2	<ul style="list-style-type: none"> <li>DC power supply input (+1 and -)</li> <li>DC reactor connection (+1 and +2)</li> </ul>	-			To connect peripheral devices, for example: <ul style="list-style-type: none"> <li>DC power input</li> <li>Braking Unit</li> <li>DC Link Choke</li> </ul> <b>Note:</b> Remove the jumper between terminals +1 and +2 to connect a DC link choke.	
+1						DC power supply input (+1 and -)
-						
+3	-		<ul style="list-style-type: none"> <li>DC power supply input (+1 and -)</li> <li>Braking unit connection (+3 and -)</li> </ul>			
	<ul style="list-style-type: none"> <li>200 V: D class grounding (ground to 100 Ω or less)</li> <li>400 V: C class grounding (ground to 10 Ω or less)</li> </ul>				To ground the drive.	

### Note:

Use terminals - and B1 to connect a CDBR-type control unit to drive models 2004 to 2138 and 4002 to 4168 that have built-in braking transistors.

## ◆ Motor and Main Circuit Connections

**⚠ WARNING** *Electrical Shock Hazard. Do not connect terminals R/L1, S/L2, T/L3, U/T1, V/T2, W/T3, -, +1, +2, +3, B1, or B2 to the ground terminal. If you connect these terminals to earth ground, it can cause damage to the drive or serious injury or death.*

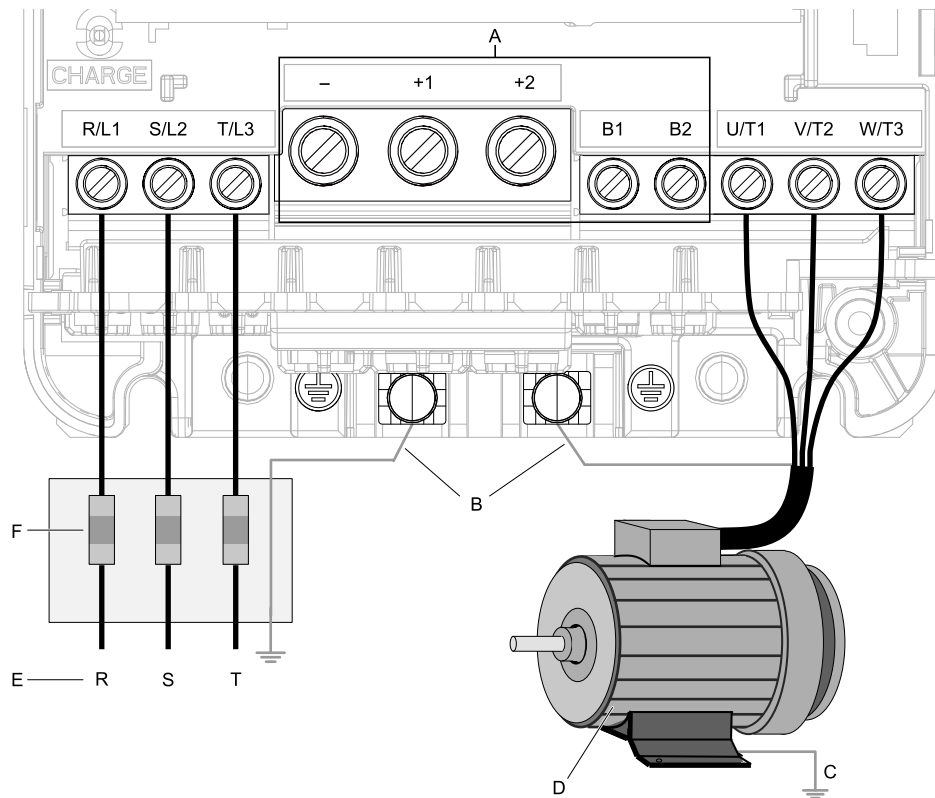
**Note:**

The location of terminals are different for different drive models.

**A - DC bus terminal**

**B - Connect to the drive ground terminal.**

**C - Ground the motor case.**

**D - Three-Phase Motor**

**E - Use R, S, T for input power supply.**

**F - Input Protection (Fuses or Circuit Breakers)**

**Figure 7.2 Wiring the Main Circuit and Motor**

## ◆ Main Circuit Terminal Block Wiring

### ■ Wire Selection

Use this section to select the correct wires for main circuit wiring.

#### Wire Selection Precautions

**⚠ WARNING** *Electrical Shock Hazard. Make sure that the protective ground wire conforms to technical standards and local safety regulations. The IEC/EN 61800-5-1:2007 standard specifies that you must wire the power supply to automatically de-energize when the protective ground wire disconnects. You can also connect a protective ground wire that has a minimum cross-sectional area of 10mm<sup>2</sup> (copper wire) or 16 mm<sup>2</sup> (aluminum wire). If you do not obey the standards and regulations, it can cause serious injury or death. The leakage current of the drive will be more than 3.5 mA in drive models 2xxxB, 2xxxC, 4002B to 4371B, 4002C to 4371C (with built-in EMC filter turned ON), and 4414 to 4720.*

Think about line voltage drop before selecting wire gauges. Select wire gauges that drop the voltage by 2% or less of the rated voltage. Increase the wire gauge and the cable length when the risk of voltage drops increases. Calculate line voltage drop with this formula:

$$\text{Line voltage drop (V)} = \sqrt{3} \times \text{wire resistance } (\Omega/\text{km}) \times \text{wiring distance (m)} \times \text{motor rated current (A)} \times 10^{-3}$$

#### Precautions during Wiring

- Use terminals B1 and - to connect braking units to drives that have built-in braking transistors (models 2004 to 2138 and 4002 to 4168). Use terminals +3 and - to connect braking units to drives that do not have built-in braking transistors.
- Refer to “Yaskawa AC Drive Option Braking Unit, Braking Resistor Unit Instruction Manual (TOBPC72060001)” for information about wire gauges and tightening torques to connect braking resistor units or braking units.

- Use terminals +1 and - to connect a regenerative converter or regenerative unit.

**⚠ WARNING** *Fire Hazard. Do not connect a braking resistor to terminals +1 or -. Use terminals B1 and B2 for the braking resistor connections. If you connect a braking resistor to the incorrect terminals, it can cause damage to the drive and braking circuit and serious injury or death.*

### Wire Gauge and Torque Specifications for UL Listing

Refer to *Three-Phase 200 V Class on page 31* and *Three-Phase 400 V Class on page 35* for the recommended wire gauges and tightening torques of the main circuit terminals.

#### Note:

- The recommended wire gauges are based on drive continuous current ratings with 75 °C (167 °F) 600 V class 2 heat-resistant indoor PVC wire. Assume these conditions:
  - Surrounding air temperature: 40 °C (104 °F) or lower
  - Wiring distance: 100 m (3281 ft) or shorter
  - Normal Duty Rated current value
- Use terminals +1, +2, +3, -, B1, and B2 to connect a peripheral option such as a DC link choke or a braking resistor. Do not connect other items to these terminals.
- Refer to the instruction manual for each device for recommended wire gauges to connect peripheral devices or options to terminals +1, +2, +3, -, B1, and B2. Contact Yaskawa or your nearest sales representative if the recommended wire gauges for the peripheral devices or options are out of the range of the applicable gauges for the drive.































#### Three-Phase 200 V Class

Model	Terminal	Recomm. Gauge AWG, kcmil	Applicable Gauge AWG, kcmil (mm <sup>2</sup> )	IP20 Applicable Gauge *7 AWG, kcmil (mm <sup>2</sup> )	Wire Stripping Length *2 mm	Terminal Screw Size and Shape	Tightening Torque N-m (lbf-in)
2004	R/L1, S/L2, T/L3	14	14 - 6 (2.5 - 16)	14 - 6 (2.5 - 16)	10	M4 ⊖	1.5 - 1.7 (13.5 - 15)
	U/T1, V/T2, W/T3	14	14 - 6 (2.5 - 16)	14 - 6 (2.5 - 16)	10	M4 ⊖	1.5 - 1.7 (13.5 - 15)
	-, +1, +2	14	14 - 3 (2.5 - 25)	14 - 3 (2.5 - 25)	18	M5 ⊖	2.3 - 2.5 (19.8 - 22) *3
	B1, B2	14	14 - 10 (2.5 - 6.0)	14 - 10 (2.5 - 6.0)	10	M4 ⊖	1.5 - 1.7 (13.5 - 15)
	⊕	10	14 - 8 (2.5 - 10)	-	-	M4 ⊕	1.2 - 1.5 (10.6 - 13.3)
2006	R/L1, S/L2, T/L3	14	14 - 6 (2.5 - 16)	14 - 6 (2.5 - 16)	10	M4 ⊖	1.5 - 1.7 (13.5 - 15)
	U/T1, V/T2, W/T3	14	14 - 6 (2.5 - 16)	14 - 6 (2.5 - 16)	10	M4 ⊖	1.5 - 1.7 (13.5 - 15)
	-, +1, +2	14	14 - 3 (2.5 - 25)	14 - 3 (2.5 - 25)	18	M5 ⊖	2.3 - 2.5 (19.8 - 22) *3
	B1, B2	14	14 - 10 (2.5 - 6.0)	14 - 10 (2.5 - 6.0)	10	M4 ⊖	1.5 - 1.7 (13.5 - 15)
	⊕	10	14 - 8 (2.5 - 10)	-	-	M4 ⊕	1.2 - 1.5 (10.6 - 13.3)
2008	R/L1, S/L2, T/L3	14	14 - 6 (2.5 - 16)	14 - 6 (2.5 - 16)	10	M4 ⊖	1.5 - 1.7 (13.5 - 15)
	U/T1, V/T2, W/T3	14	14 - 6 (2.5 - 16)	14 - 6 (2.5 - 16)	10	M4 ⊖	1.5 - 1.7 (13.5 - 15)
	-, +1, +2	14	14 - 3 (2.5 - 25)	14 - 3 (2.5 - 25)	18	M5 ⊖	2.3 - 2.5 (19.8 - 22) *3
	B1, B2	14	14 - 10 (2.5 - 6.0)	14 - 10 (2.5 - 6.0)	10	M4 ⊖	1.5 - 1.7 (13.5 - 15)
	⊕	10	14 - 8 (2.5 - 10)	-	-	M4 ⊕	1.2 - 1.5 (10.6 - 13.3)































## 7 Electrical Installation

Model	Terminal	Recomm. Gauge AWG, kcmil	Applicable Gauge AWG, kcmil (mm <sup>2</sup> )	IP20 Applicable Gauge *1 AWG, kcmil (mm <sup>2</sup> )	Wire Stripping Length *2 mm	Terminal Screw Size and Shape	Tightening Torque N-m (lbf-in)
2010	R/L1, S/L2, T/L3	12	14 - 6 (2.5 - 16)	14 - 6 (2.5 - 16)	10	M4 ⊖	1.5 - 1.7 (13.5 - 15)
	U/T1, V/T2, W/T3	14	14 - 6 (2.5 - 16)	14 - 6 (2.5 - 16)	10	M4 ⊖	1.5 - 1.7 (13.5 - 15)
	-, +1, +2	12	14 - 3 (2.5 - 25)	14 - 3 (2.5 - 25)	18	M5 ⊖	2.3 - 2.5 (19.8 - 22) *3
	B1, B2	14	14 - 10 (2.5 - 6.0)	14 - 10 (2.5 - 6.0)	10	M4 ⊖	1.5 - 1.7 (13.5 - 15)
	⊕	10	14 - 8 (2.5 - 10)	-	-	M4 ⊕	1.2 - 1.5 (10.6 - 13.3)
2012	R/L1, S/L2, T/L3	10	14 - 6 (2.5 - 16)	14 - 6 (2.5 - 16)	10	M4 ⊖	1.5 - 1.7 (13.5 - 15)
	U/T1, V/T2, W/T3	12	14 - 6 (2.5 - 16)	14 - 6 (2.5 - 16)	10	M4 ⊖	1.5 - 1.7 (13.5 - 15)
	-, +1, +2	10	14 - 3 (2.5 - 25)	14 - 3 (2.5 - 25)	18	M5 ⊖	2.3 - 2.5 (19.8 - 22) *3
	B1, B2	14	14 - 10 (2.5 - 6.0)	14 - 10 (2.5 - 6.0)	10	M4 ⊖	1.5 - 1.7 (13.5 - 15)
	⊕	10	14 - 8 (2.5 - 10)	-	-	M4 ⊕	1.2 - 1.5 (10.6 - 13.3)
2018	R/L1, S/L2, T/L3	10	14 - 6 (2.5 - 16)	14 - 6 (2.5 - 16)	10	M4 ⊖	1.5 - 1.7 (13.5 - 15)
	U/T1, V/T2, W/T3	10	14 - 6 (2.5 - 16)	14 - 6 (2.5 - 16)	10	M4 ⊖	1.5 - 1.7 (13.5 - 15)
	-, +1, +2	8	14 - 3 (2.5 - 25)	14 - 3 (2.5 - 25)	18	M5 ⊖	2.3 - 2.5 (19.8 - 22) *3
	B1, B2	14	14 - 10 (2.5 - 6.0)	14 - 10 (2.5 - 6.0)	10	M4 ⊖	1.5 - 1.7 (13.5 - 15)
	⊕	10	14 - 8 (2.5 - 10)	-	-	M4 ⊕	1.2 - 1.5 (10.6 - 13.3)
2021	R/L1, S/L2, T/L3	8	14 - 6 (2.5 - 16)	14 - 6 (2.5 - 16)	10	M4 ⊖	1.5 - 1.7 (13.5 - 15)
	U/T1, V/T2, W/T3	10	14 - 6 (2.5 - 16)	14 - 6 (2.5 - 16)	10	M4 ⊖	1.5 - 1.7 (13.5 - 15)
	-, +1, +2	8	14 - 3 (2.5 - 25)	14 - 3 (2.5 - 25)	18	M5 ⊖	2.3 - 2.5 (19.8 - 22) *3
	B1, B2	14	14 - 10 (2.5 - 6.0)	14 - 10 (2.5 - 6.0)	10	M4 ⊖	1.5 - 1.7 (13.5 - 15)
	⊕	10	12 - 8 (4.0 - 10)	-	-	M4 ⊕	1.2 - 1.5 (10.6 - 13.3)
2030	R/L1, S/L2, T/L3	6	14 - 6 (2.5 - 16)	14 - 6 (2.5 - 16)	10	M4 ⊖	1.5 - 1.7 (13.5 - 15)
	U/T1, V/T2, W/T3	8	14 - 6 (2.5 - 16)	14 - 6 (2.5 - 16)	10	M4 ⊖	1.5 - 1.7 (13.5 - 15)
	-, +1, +2	6	14 - 3 (2.5 - 25)	14 - 3 (2.5 - 25)	18	M5 ⊖	2.3 - 2.5 (19.8 - 22) *3
	B1, B2	12	14 - 10 (2.5 - 6.0)	14 - 10 (2.5 - 6.0)	10	M4 ⊖	1.5 - 1.7 (13.5 - 15)
	⊕	8	10 - 8 (6.0 - 10)	-	-	M5 ⊕	2.0 - 2.5 (17.7 - 22.1)



Model	Terminal	Recomm. Gauge AWG, kcmil	Applicable Gauge AWG, kcmil (mm <sup>2</sup> )	IP20 Applicable Gauge *1 AWG, kcmil (mm <sup>2</sup> )	Wire Stripping Length *2 mm	Terminal Screw Size and Shape	Tightening Torque N-m (lbf-in)
2042	R/L1, S/L2, T/L3	6	14 - 6 (2.5 - 16)	14 - 6 (2.5 - 16)	10	M4 	1.5 - 1.7 (13.5 - 15)
	U/T1, V/T2, W/T3	6	14 - 6 (2.5 - 16)	14 - 6 (2.5 - 16)	10	M4 	1.5 - 1.7 (13.5 - 15)
	-, +1, +2	3	14 - 3 (2.5 - 25)	14 - 3 (2.5 - 25)	18	M5 	2.3 - 2.5 (19.8 - 22) *3
	B1, B2	10	14 - 10 (2.5 - 6.0)	14 - 10 (2.5 - 6.0)	10	M4 	1.5 - 1.7 (13.5 - 15)
		8	10 - 8 (6.0 - 10)	-	-	M5 	2.0 - 2.5 (17.7 - 22.1)
2056	R/L1, S/L2, T/L3	3	14 - 3 (2.5 - 25)	8 - 3 (10 - 25)	18	M5 	2.3 - 2.5 (19.8 - 22) *3
	U/T1, V/T2, W/T3	4	14 - 4 (2.5 - 25)	10 - 4 (6.0 - 25)	18	M5 	2.3 - 2.5 (19.8 - 22) *3
	-, +1, +2	1	14 - 1 (2.5 - 50)	8 - 1 (10 - 50)	20	M6 	5 - 5.5 (45 - 49)
	B1, B2	8	14 - 8 (2.5 - 10)	14 - 8 (2.5 - 10)	10	M4 	1.5 - 1.7 (13.5 - 15)
		6	8 - 6 (10 - 16)	-	-	M6 	5.4 - 6.0 (47.8 - 53.1)
2070	R/L1, S/L2, T/L3	1	14 - 1 (2.5 - 50)	6 - 1 (16 - 50)	20	M6 	5 - 5.5 (45 - 49)
	U/T1, V/T2, W/T3	3	14 - 3 (2.5 - 25)	6 - 3 (16 - 25)	20	M6 	5 - 5.5 (45 - 49)
	-, +1, +2	1/0	14 - 1/0 (2.5 - 50)	14 - 1/0 (2.5 - 50)	20	M6 	5 - 5.5 (45 - 49)
	B1, B2	8	14 - 8 (2.5 - 10)	14 - 8 (2.5 - 10)	10	M4 	1.5 - 1.7 (13.5 - 15)
		6	6 - 4 (16 - 25)	-	-	M6 	5.4 - 6.0 (47.8 - 53.1)
2082	R/L1, S/L2, T/L3	1/0	14 - 1/0 (2.5 - 50)	6 - 1/0 (16 - 50)	20	M6 	5 - 5.5 (45 - 49)
	U/T1, V/T2, W/T3	2	14 - 2 (2.5 - 35)	6 - 2 (16 - 35)	20	M6 	5 - 5.5 (45 - 49)
	-, +1, +2	2/0	14 - 2/0 (2.5 - 70)	14 - 2/0 (2.5 - 70)	20	M6 	5 - 5.5 (45 - 49)
	B1, B2	6	14 - 6 (2.5 - 16)	14 - 6 (2.5 - 16)	10	M4 	1.5 - 1.7 (13.5 - 15)
		6	6 - 4 (16 - 25)	-	-	M6 	5.4 - 6.0 (47.8 - 53.1)
2110	R/L1, S/L2, T/L3	1/0	6 - 1/0 (16 - 50)	6 - 1/0 (16 - 50)	27	M6 	8 - 9 (71 - 80)
	U/T1, V/T2, W/T3	1/0	6 - 1/0 (16 - 50)	6 - 1/0 (16 - 50)	27	M6 	8 - 9 (71 - 80)
	-, +1	2/0	2 - 2/0 (35 - 70)	2 - 2/0 (35 - 70)	27	M8 	10 - 12 (89 - 107)
	B1, B2	4	14 - 4 (2.5 - 25)	10 - 4 (6.0 - 25)	21	M6 	3 - 3.5 (27 - 31)
		6	6 - 4 (16 - 25)	-	-	M6 	5.4 - 6.0 (47.8 - 53.1)

## 7 Electrical Installation

Model	Terminal	Recomm. Gauge AWG, kcmil	Applicable Gauge AWG, kcmil (mm <sup>2</sup> )	IP20 Applicable Gauge <sup>*1</sup> AWG, kcmil (mm <sup>2</sup> )	Wire Stripping Length <sup>*2</sup> mm	Terminal Screw Size and Shape	Tightening Torque N-m (lbf-in)
2138	R/L1, S/L2, T/L3	2/0	6 - 2/0 (16 - 70)	2 - 2/0 (35 - 70)	27	M6 	8 - 9 (71 - 80)
	U/T1, V/T2, W/T3	2/0	6 - 2/0 (16 - 70)	2 - 2/0 (35 - 70)	27	M6 	8 - 9 (71 - 80)
	-, +1	4/0	2 - 4/0 (35 - 95)	2 - 4/0 (35 - 95)	27	M8 	10 - 12 (89 - 107)
	B1, B2	3	14 - 3 (2.5 - 25)	10 - 3 (6.0 - 25)	21	M6 	3 - 3.5 (27 - 31)
		4	4 (25)	-	-	M6 	5.4 - 6.0 (47.8 - 53.1)
2169	R/L1, S/L2, T/L3	4/0	2 - 250 (35 - 120)	2/0 - 250 (70 - 120)	37	M10 	12 - 14 (107 - 124)
	U/T1, V/T2, W/T3	4/0	2 - 300 (35 - 150)	3/0 - 300 (95 - 150)	37	M10 	12 - 14 (107 - 124)
	-, -, +1, +1 <sup>*4 *5</sup>	1	6 - 2/0 (16 - 70)	1/0 - 2/0 (50 - 70)	28	M6 	8 - 9 (71 - 80)
	+3 <sup>*5</sup>	1/0	4 - 2/0 (25 - 70)	1 - 2/0 (50 - 70)	28	M8 	8 - 9 (71 - 80)
		4	4 - 1/0 (25 - 50)	-	-	M8 	9.0 - 11 (79.7 - 97.4)
2211	R/L1, S/L2, T/L3	250	2 - 250 (35 - 120)	2/0 - 250 (70 - 120)	37	M10 	12 - 14 (107 - 124)
	U/T1, V/T2, W/T3	300	2 - 300 (35 - 150)	3/0 - 300 (95 - 150)	37	M10 	12 - 14 (107 - 124)
	-, -, +1, +1 <sup>*4 *5</sup>	2/0	6 - 2/0 (16 - 70)	1/0 - 2/0 (50 - 70)	28	M6 	8 - 9 (71 - 80)
	+3 <sup>*5</sup>	2/0	4 - 2/0 (25 - 70)	1 - 2/0 (35 - 70)	28	M8 	8 - 9 (71 - 80)
		4	4 - 1/0 (25 - 50)	-	-	M8 	9.0 - 11 (79.7 - 97.4)
2257	R/L1, S/L2, T/L3	2/0 × 2P	3 - 4/0 × 2P (25 - 95 × 2P)	2/0 - 4/0 × 2P (70 - 95 × 2P)	-	M10 	20 (177)
	U/T1, V/T2, W/T3	2/0 × 2P	3 - 4/0 × 2P (25 - 95 × 2P)	2/0 - 4/0 × 2P (70 - 95 × 2P)	-	M10 	20 (177)
	-, +1	4/0 × 2P	2 - 250 × 2P (35 - 120 × 2P)	4/0 - 250 × 2P (95 × 2P)	-	M10 	20 (177)
	+3	1/0 × 2P	4 - 1/0 × 2P (25 - 50 × 2P)	1/0 × 2P (50 × 2P)	-	M10 	20 (177)
		3	3 - 350 (25 - 185)	-	-	M10 	18 - 23 (159 - 204)
2313	R/L1, S/L2, T/L3	4/0 × 2P	3 - 4/0 × 2P (25 - 95 × 2P)	2/0 - 4/0 × 2P (70 - 95 × 2P)	-	M10 	20 (177)
	U/T1, V/T2, W/T3	3/0 × 2P	3 - 4/0 × 2P (25 - 95 × 2P)	2/0 - 4/0 × 2P (70 - 95 × 2P)	-	M10 	20 (177)
	-, +1	250 × 2P	2 - 250 × 2P (35 - 120 × 2P)	4/0 - 250 × 2P (95 × 2P)	-	M10 	20 (177)
	+3	1/0 × 2P	4 - 1/0 × 2P (25 - 50 × 2P)	1/0 × 2P (50 × 2P)	-	M10 	20 (177)
		2	2 - 350 (35 - 150)	-	-	M10 	18 - 23 (159 - 204)

Model	Terminal	Recomm. Gauge AWG, kcmil	Applicable Gauge AWG, kcmil (mm <sup>2</sup> )	IP20 Applicable Gauge *1 AWG, kcmil (mm <sup>2</sup> )	Wire Stripping Length *2 mm	Terminal Screw Size and Shape	Tightening Torque N·m (lbf·in)
2360	R/L1, S/L2, T/L3	250 × 2P	2/0 - 300 × 2P (70 - 150 × 2P)	250 - 300 × 2P (120 - 150 × 2P)	-	M12	35 (310)
	U/T1, V/T2, W/T3	250 × 2P	2/0 - 300 × 2P (70 - 150 × 2P)	250 - 300 × 2P (120 - 150 × 2P)	-	M12	35 (310)
	-, +1	350 × 2P	4/0 - 400 × 2P (95 - 185 × 2P)	300 - 400 × 2P (150 - 185 × 2P)	-	M12	35 (310)
	+3	3/0 × 2P	1/0 - 4/0 × 2P (50 - 95 × 2P)	-	-	M12	35 (310)
		1	1 - 350 (50 - 150)	-	-	M12	32 - 40 (283 - 354)
2415	R/L1, S/L2, T/L3	250 × 2P	2/0 - 300 × 2P (70 - 150 × 2P)	250 - 300 × 2P (120 - 150 × 2P)	-	M12	35 (310)
	U/T1, V/T2, W/T3	300 × 2P	2/0 - 300 × 2P (70 - 150 × 2P)	250 - 300 × 2P (120 - 150 × 2P)	-	M12	35 (310)
	-, +1	350 × 2P	4/0 - 400 × 2P (95 - 185 × 2P)	300 - 400 × 2P (150 - 185 × 2P)	-	M12	35 (310)
	+3	3/0 × 2P	1/0 - 4/0 × 2P (50 - 95 × 2P)	-	-	M12	35 (310)
		1	1 - 350 (50 - 150)	-	-	M12	32 - 40 (283 - 354)

\*1 For IP20 protection, use wires that are in the range of applicable gauges.

\*2 Remove insulation from the ends of wires to expose the length of wire shown.

\*3 For wire gauges more than AWG 8, tighten to a tightening torque of 4.1 N·m to 4.5 N·m (36 lbf·in to 40 lbf·in).

\*4 Terminals - and +1 have two screws. The Recommended Gauge is the wire gauge for one terminal.

\*5 A junction terminal is necessary to connect a braking unit (CDBR-series) to terminals - and +3.

### Three-Phase 400 V Class

Model	Terminal	Recomm. Gauge AWG, kcmil	Applicable Gauge AWG, kcmil (mm <sup>2</sup> )	IP20 Applicable Gauge *1 AWG, kcmil (mm <sup>2</sup> )	Wire Stripping Length *2 mm	Terminal Screw Size and Shape	Tightening Torque N·m (lbf·in)
4002	R/L1, S/L2, T/L3	14	14 - 6 (2.5 - 16)	14 - 6 (2.5 - 16)	10	M4	1.5 - 1.7 (13.5 - 15)
	U/T1, V/T2, W/T3	14	14 - 6 (2.5 - 16)	14 - 6 (2.5 - 16)	10	M4	1.5 - 1.7 (13.5 - 15)
	-, +1, +2	14	14 - 3 (2.5 - 25)	14 - 3 (2.5 - 25)	18	M5	2.3 - 2.5 (19.8 - 22) *3
	B1, B2	14	14 - 10 (2.5 - 6.0)	14 - 10 (2.5 - 6.0)	10	M4	1.5 - 1.7 (13.5 - 15)
		12	14 - 8 (2.5 - 10)	-	-	M4	1.2 - 1.5 (10.6 - 13.3)
4004	R/L1, S/L2, T/L3	14	14 - 6 (2.5 - 16)	14 - 6 (2.5 - 16)	10	M4	1.5 - 1.7 (13.5 - 15)
	U/T1, V/T2, W/T3	14	14 - 6 (2.5 - 16)	14 - 6 (2.5 - 16)	10	M4	1.5 - 1.7 (13.5 - 15)
	-, +1, +2	14	14 - 3 (2.5 - 25)	14 - 3 (2.5 - 25)	18	M5	2.3 - 2.5 (19.8 - 22) *3
	B1, B2	14	14 - 10 (2.5 - 6.0)	14 - 10 (2.5 - 6.0)	10	M4	1.5 - 1.7 (13.5 - 15)
		12	14 - 8 (2.5 - 10)	-	-	M4	1.2 - 1.5 (10.6 - 13.3)































## 7 Electrical Installation

























Model	Terminal	Recomm. Gauge AWG, kcmil	Applicable Gauge AWG, kcmil (mm <sup>2</sup> )	IP20 Applicable Gauge *1 AWG, kcmil (mm <sup>2</sup> )	Wire Stripping Length *2 mm	Terminal Screw Size and Shape	Tightening Torque N-m (lbf-in)
4005	R/L1, S/L2, T/L3	14	14 - 6 (2.5 - 16)	14 - 6 (2.5 - 16)	10	M4 ⊖	1.5 - 1.7 (13.5 - 15)
	U/T1, V/T2, W/T3	14	14 - 6 (2.5 - 16)	14 - 6 (2.5 - 16)	10	M4 ⊖	1.5 - 1.7 (13.5 - 15)
	-, +1, +2	14	14 - 3 (2.5 - 25)	14 - 3 (2.5 - 25)	18	M5 ⊖	2.3 - 2.5 (19.8 - 22) *3
	B1, B2	14	14 - 10 (2.5 - 6.0)	14 - 10 (2.5 - 6.0)	10	M4 ⊖	1.5 - 1.7 (13.5 - 15)
	⊕	10	14 - 8 (2.5 - 10)	-	-	M4 ⊕	1.2 - 1.5 (10.6 - 13.3)
4007	R/L1, S/L2, T/L3	14	14 - 6 (2.5 - 16)	14 - 6 (2.5 - 16)	10	M4 ⊖	1.5 - 1.7 (13.5 - 15)
	U/T1, V/T2, W/T3	14	14 - 6 (2.5 - 16)	14 - 6 (2.5 - 16)	10	M4 ⊖	1.5 - 1.7 (13.5 - 15)
	-, +1, +2	14	14 - 3 (2.5 - 25)	14 - 3 (2.5 - 25)	18	M5 ⊖	2.3 - 2.5 (19.8 - 22) *3
	B1, B2	14	14 - 10 (2.5 - 6.0)	14 - 10 (2.5 - 6.0)	10	M4 ⊖	1.5 - 1.7 (13.5 - 15)
	⊕	10	14 - 8 (2.5 - 10)	-	-	M4 ⊕	1.2 - 1.5 (10.6 - 13.3)
4009	R/L1, S/L2, T/L3	14	14 - 6 (2.5 - 16)	14 - 6 (2.5 - 16)	10	M4 ⊖	1.5 - 1.7 (13.5 - 15)
	U/T1, V/T2, W/T3	14	14 - 6 (2.5 - 16)	14 - 6 (2.5 - 16)	10	M4 ⊖	1.5 - 1.7 (13.5 - 15)
	-, +1, +2	12	14 - 3 (2.5 - 25)	14 - 3 (2.5 - 25)	18	M5 ⊖	2.3 - 2.5 (19.8 - 22) *3
	B1, B2	14	14 - 10 (2.5 - 6.0)	14 - 10 (2.5 - 6.0)	10	M4 ⊖	1.5 - 1.7 (13.5 - 15)
	⊕	10	14 - 8 (2.5 - 10)	-	-	M4 ⊕	1.2 - 1.5 (10.6 - 13.3)
4012	R/L1, S/L2, T/L3	12	14 - 6 (2.5 - 16)	14 - 6 (2.5 - 16)	10	M4 ⊖	1.5 - 1.7 (13.5 - 15)
	U/T1, V/T2, W/T3	14	14 - 6 (2.5 - 16)	14 - 6 (2.5 - 16)	10	M4 ⊖	1.5 - 1.7 (13.5 - 15)
	-, +1, +2	10	14 - 3 (2.5 - 25)	14 - 3 (2.5 - 25)	18	M5 ⊖	2.3 - 2.5 (19.8 - 22) *3
	B1, B2	14	14 - 10 (2.5 - 6.0)	14 - 10 (2.5 - 6.0)	10	M4 ⊖	1.5 - 1.7 (13.5 - 15)
	⊕	10	14 - 8 (2.5 - 10)	-	-	M4 ⊕	1.2 - 1.5 (10.6 - 13.3)
4018	R/L1, S/L2, T/L3	10	14 - 6 (2.5 - 16)	14 - 6 (2.5 - 16)	10	M4 ⊖	1.5 - 1.7 (13.5 - 15)
	U/T1, V/T2, W/T3	10	14 - 6 (2.5 - 16)	14 - 6 (2.5 - 16)	10	M4 ⊖	1.5 - 1.7 (13.5 - 15)
	-, +1, +2	8	14 - 3 (2.5 - 25)	14 - 3 (2.5 - 25)	18	M5 ⊖	2.3 - 2.5 (19.8 - 22) *3
	B1, B2	14	14 - 10 (2.5 - 6.0)	14 - 10 (2.5 - 6.0)	10	M4 ⊖	1.5 - 1.7 (13.5 - 15)
	⊕	10	14 - 8 (2.5 - 10)	-	-	M5 ⊕	2.0 - 2.5 (17.7 - 22.1)

Model	Terminal	Recomm. Gauge AWG, kcmil	Applicable Gauge AWG, kcmil (mm <sup>2</sup> )	IP20 Applicable Gauge *1 AWG, kcmil (mm <sup>2</sup> )	Wire Stripping Length *2 mm	Terminal Screw Size and Shape	Tightening Torque N·m (lbf·in)
4023	R/L1, S/L2, T/L3	8	14 - 6 (2.5 - 16)	14 - 6 (2.5 - 16)	10	M4 ⊖	1.5 - 1.7 (13.5 - 15)
	U/T1, V/T2, W/T3	10	14 - 6 (2.5 - 16)	14 - 6 (2.5 - 16)	10	M4 ⊖	1.5 - 1.7 (13.5 - 15)
	-, +1, +2	8	14 - 3 (2.5 - 25)	14 - 3 (2.5 - 25)	18	M5 ⊖	2.3 - 2.5 (19.8 - 22) *3
	B1, B2	12	14 - 10 (2.5 - 6.0)	14 - 10 (2.5 - 6.0)	10	M4 ⊖	1.5 - 1.7 (13.5 - 15)
	⊕	10	12 - 8 (4.0 - 10)	-	-	M5 ⊕	2.0 - 2.5 (17.7 - 22.1)
4031	R/L1, S/L2, T/L3	6	14 - 3 (2.5 - 25)	8 - 3 (10 - 25)	18	M5 ⊖	2.3 - 2.5 (19.8 - 22) *3
	U/T1, V/T2, W/T3	8	14 - 4 (2.5 - 25)	10 - 4 (6.0 - 25)	18	M5 ⊖	2.3 - 2.5 (19.8 - 22) *3
	-, +1, +2	6	14 - 1 (2.5 - 50)	8 - 1 (10 - 50)	20	M6 ⊖	5 - 5.5 (45 - 49)
	B1, B2	10	14 - 8 (2.5 - 10)	14 - 8 (2.5 - 10)	10	M4 ⊖	1.5 - 1.7 (13.5 - 15)
	⊕	8	10 - 6 (6.0 - 16)	-	-	M6 ⊕	5.4 - 6.0 (47.8 - 53.1)
4038	R/L1, S/L2, T/L3	6	14 - 3 (2.5 - 25)	8 - 3 (10 - 25)	18	M5 ⊖	2.3 - 2.5 (19.8 - 22) *3
	U/T1, V/T2, W/T3	8	14 - 4 (2.5 - 25)	10 - 4 (6.0 - 25)	18	M5 ⊖	2.3 - 2.5 (19.8 - 22) *3
	-, +1, +2	4	14 - 1 (2.5 - 50)	8 - 1 (10 - 50)	20	M6 ⊖	5 - 5.5 (45 - 49)
	B1, B2	10	14 - 8 (2.5 - 10)	14 - 8 (2.5 - 10)	10	M4 ⊖	1.5 - 1.7 (13.5 - 15)
	⊕	6	10 - 6 (6.0 - 16)	-	-	M6 ⊕	5.4 - 6.0 (47.8 - 53.1)
4044	R/L1, S/L2, T/L3	4	14 - 4 (2.5 - 25)	10 - 4 (6.0 - 25)	18	M5 ⊖	2.3 - 2.5 (19.8 - 22) *3
	U/T1, V/T2, W/T3	6	14 - 6 (2.5 - 16)	10 - 6 (6.0 - 16)	18	M5 ⊖	2.3 - 2.5 (19.8 - 22) *3
	-, +1, +2	3	14 - 3 (2.5 - 25)	10 - 3 (6.0 - 25)	18	M5 ⊖	2.3 - 2.5 (19.8 - 22) *3
	B1, B2	8	14 - 8 (2.5 - 10)	14 - 8 (2.5 - 10)	10	M4 ⊖	1.5 - 1.7 (13.5 - 15)
	⊕	6	8 - 4 (10 - 25)	-	-	M6 ⊕	5.4 - 6.0 (47.8 - 53.1)
4060	R/L1, S/L2, T/L3	4	14 - 4 (2.5 - 25)	10 - 4 (6.0 - 25)	18	M5 ⊖	2.3 - 2.5 (19.8 - 22) *3
	U/T1, V/T2, W/T3	4	14 - 4 (2.5 - 25)	10 - 4 (6.0 - 25)	18	M5 ⊖	2.3 - 2.5 (19.8 - 22) *3
	-, +1	3	14 - 3 (2.5 - 25)	10 - 3 (6.0 - 25)	18	M5 ⊖	2.3 - 2.5 (19.8 - 22) *3
	B1, B2	8	14 - 8 (2.5 - 10)	14 - 8 (2.5 - 10)	10	M4 ⊖	1.5 - 1.7 (13.5 - 15)
	⊕	6	8 - 4 (10 - 25)	-	-	M6 ⊕	5.4 - 6.0 (47.8 - 53.1)

## 7 Electrical Installation

Model	Terminal	Recomm. Gauge AWG, kcmil	Applicable Gauge AWG, kcmil (mm <sup>2</sup> )	IP20 Applicable Gauge *1 AWG, kcmil (mm <sup>2</sup> )	Wire Stripping Length *2 mm	Terminal Screw Size and Shape	Tightening Torque N-m (lbf-in)
4075	R/L1, S/L2, T/L3	3	14 - 3 (2.5 - 25)	12 - 3 (4.0 - 25)	18	M5	2.3 - 2.5 (19.8 - 22) *3
	U/T1, V/T2, W/T3	3	14 - 3 (2.5 - 25)	12 - 3 (4.0 - 25)	18	M5	2.3 - 2.5 (19.8 - 22) *3
	-, +1	2	14 - 2 (2.5 - 35)	10 - 2 (6.0 - 35)	18	M5	2.3 - 2.5 (19.8 - 22) *3
	B1, B2	6	14 - 6 (2.5 - 16)	14 - 6 (2.5 - 16)	10	M4	1.5 - 1.7 (13.5 - 15)
		6	6 - 4 (16 - 25)	-	-	M6	5.4 - 6.0 (47.8 - 53.1)
4089	R/L1, S/L2, T/L3	2	14 - 2 (2.5 - 35)	10 - 2 (6.0 - 35)	18	M5	2.3 - 2.5 (19.8 - 22) *3
	U/T1, V/T2, W/T3	2	14 - 2 (2.5 - 35)	10 - 2 (6.0 - 35)	18	M5	2.3 - 2.5 (19.8 - 22) *3
	-, +1	1/0	14 - 1/0 (2.5 - 50)	6 - 1/0 (16 - 50)	20	M6	5 - 5.5 (45 - 49)
	B1, B2	6	14 - 6 (2.5 - 16)	14 - 6 (2.5 - 16)	18	M5	2.3 - 2.5 (19.8 - 22) *3
		4	6 - 4 (16 - 25)	-	-	M6	5.4 - 6.0 (47.8 - 53.1)
4103	R/L1, S/L2, T/L3	1/0	6 - 2/0 (16 - 70)	2 - 2/0 (35 - 70)	27	M6	8 - 9 (71 - 80)
	U/T1, V/T2, W/T3	1	6 - 2/0 (16 - 70)	2 - 2/0 (35 - 70)	27	M6	8 - 9 (71 - 80)
	-, +1	2/0	2 - 4/0 (35 - 95)	2 - 4/0 (35 - 95)	27	M8	10 - 12 (89 - 107)
	B1, B2	3	14 - 3 (2.5 - 25)	10 - 3 (6.0 - 25)	21	M6	3 - 3.5 (27 - 31)
		4	6 - 4 (16 - 25)	-	-	M6	5.4 - 6.0 (47.8 - 53.1)
4140	R/L1, S/L2, T/L3	3/0	2 - 250 (35 - 120)	2/0 - 250 (70 - 120)	37	M10	12 - 14 (107 - 124)
	U/T1, V/T2, W/T3	2/0	2 - 300 (35 - 150)	3/0 - 300 (95 - 150)	37	M10	12 - 14 (107 - 124)
	-, -, +1, +1 *4	2	6 - 2/0 (16 - 70)	1/0 - 2/0 (50 - 70)	28	M6	8 - 9 (71 - 80)
	B1, B2 *5	1	4 - 2/0 (25 - 70)	1 - 2/0 (50 - 70)	28	M8	8 - 9 (71 - 80)
		4	4 - 1/0 (25 - 50)	-	-	M8	9.0 - 11 (79.7 - 97.4)
4168	R/L1, S/L2, T/L3	4/0	2 - 250 (35 - 120)	2/0 - 250 (70 - 120)	37	M10	12 - 14 (107 - 124)
	U/T1, V/T2, W/T3	4/0	2 - 300 (35 - 150)	3/0 - 300 (95 - 150)	37	M10	12 - 14 (107 - 124)
	-, -, +1, +1 *4	1/0	6 - 2/0 (16 - 70)	1/0 - 2/0 (50 - 70)	28	M6	8 - 9 (71 - 80)
	B1, B2 *5	1/0	4 - 2/0 (25 - 70)	1 - 2/0 (50 - 70)	28	M8	8 - 9 (71 - 80)
		4	4 - 1/0 (25 - 50)	-	-	M8	9.0 - 11 (79.7 - 97.4)

Model	Terminal	Recomm. Gauge AWG, kcmil	Applicable Gauge AWG, kcmil (mm <sup>2</sup> )	IP20 Applicable Gauge *1 AWG, kcmil (mm <sup>2</sup> )	Wire Stripping Length *2 mm	Terminal Screw Size and Shape	Tightening Torque N·m (lbf·in)
4208	R/L1, S/L2, T/L3	1/0 × 2P	3 - 4/0 × 2P (25 - 95 × 2P)	2/0 - 4/0 × 2P (70 - 95 × 2P)	-	M10 	20 (177)
	U/T1, V/T2, W/T3	1/0 × 2P	3 - 4/0 × 2P (25 - 95 × 2P)	2/0 - 4/0 × 2P (70 - 95 × 2P)	-	M10 	20 (177)
	-, +1	3/0 × 2P	2 - 250 × 2P (35 - 120 × 2P)	4/0 - 250 × 2P (95 × 2P)	-	M10 	20 (177)
	+3	1/0 × 2P	4 - 1/0 × 2P (25 - 50 × 2P)	1/0 × 2P (50 × 2P)	-	M10 	20 (177)
		4	4 - 350 (25 - 150)	-	-	M10 	18 - 23 (159 - 204)
4250	R/L1, S/L2, T/L3	2/0 × 2P	3 - 4/0 × 2P (25 - 95 × 2P)	2/0 - 4/0 × 2P (70 - 95 × 2P)	-	M10 	20 (177)
	U/T1, V/T2, W/T3	2/0 × 2P	3 - 4/0 × 2P (25 - 95 × 2P)	2/0 - 4/0 × 2P (70 - 95 × 2P)	-	M10 	20 (177)
	-, +1	3/0 × 2P	2 - 250 × 2P (35 - 120 × 2P)	4/0 - 250 × 2P (95 × 2P)	-	M10 	20 (177)
	+3	1/0 × 2P	4 - 1/0 × 2P (25 - 50 × 2P)	1/0 × 2P (50 × 2P)	-	M10 	20 (177)
		2	2 - 350 (35 - 150)	-	-	M10 	18 - 23 (159 - 204)
4302	R/L1, S/L2, T/L3	3/0 × 2P	3 - 4/0 × 2P (25 - 95 × 2P)	2/0 - 4/0 × 2P (70 - 95 × 2P)	-	M10 	20 (177)
	U/T1, V/T2, W/T3	3/0 × 2P	3 - 4/0 × 2P (25 - 95 × 2P)	2/0 - 4/0 × 2P (70 - 95 × 2P)	-	M10 	20 (177)
	-, +1	4/0 × 2P	2 - 250 × 2P (35 - 120 × 2P)	4/0 - 250 × 2P (95 × 2P)	-	M10 	20 (177)
	+3	1/0 × 2P	4 - 1/0 × 2P (25 - 50 × 2P)	1/0 × 2P (50 × 2P)	-	M10 	20 (177)
		2	2 - 350 (35 - 185)	-	-	M10 	18 - 23 (159 - 204)
4371	R/L1, S/L2, T/L3	250 × 2P	2/0 - 300 × 2P (70 - 150 × 2P)	250 - 300 × 2P (120 - 150 × 2P)	-	M12 	35 (310)
	U/T1, V/T2, W/T3	250 × 2P	2/0 - 300 × 2P (70 - 150 × 2P)	250 - 300 × 2P (120 - 150 × 2P)	-	M12 	35 (310)
	-, +1	350 × 2P	4/0 - 400 × 2P (95 - 185 × 2P)	300 - 400 × 2P (150 - 185 × 2P)	-	M12 	35 (310)
	+3	3/0 × 2P	1 - 4/0 × 2P (50 - 95 × 2P)	-	-	M12 	35 (310)
		1	1 - 350 (50 - 185)	-	-	M12 	32 - 40 (283 - 354)
4414	R/L1, S/L2, T/L3	300 × 2P	2/0 - 300 × 2P (70 - 150 × 2P)	250 - 300 × 2P (120 - 150 × 2P)	-	M12 	35 (310)
	U/T1, V/T2, W/T3	300 × 2P	2/0 - 300 × 2P (70 - 150 × 2P)	250 - 300 × 2P (120 - 150 × 2P)	-	M12 	35 (310)
	-, +1	400 × 2P	4/0 - 400 × 2P (95 - 185 × 2P)	300 - 400 × 2P (150 - 185 × 2P)	-	M12 	35 (310)
	+3	4/0 × 2P	1 - 4/0 × 2P (50 - 95 × 2P)	-	-	M12 	35 (310)
		1	1 - 350 (35 - 185)	-	-	M12 	32 - 40 (283 - 354)

Model	Terminal	Recomm. Gauge AWG, kcmil	Applicable Gauge AWG, kcmil (mm <sup>2</sup> )	IP20 Applicable Gauge <sup>*1</sup> AWG, kcmil (mm <sup>2</sup> )	Wire Stripping Length <sup>*2</sup> mm	Terminal Screw Size and Shape	Tightening Torque N·m (lbf·in)
4477	R/L1, S/L2, T/L3	250 × 4P	2/0 - 300 × 4P (70 - 150 × 4P)	250 - 300 × 4P (120 - 150 × 4P)	-	M12 	35 (310)
	U/T1, V/T2, W/T3	4/0 × 4P	2/0 - 300 × 4P (70 - 150 × 4P)	250 - 300 × 4P (120 - 150 × 4P)	-	M12 	35 (310)
	-, +1	4/0 × 4P	3/0 - 400 × 4P (95 - 185 × 4P)	300 - 400 × 4P (150 - 185 × 4P)	-	M12 	35 (310)
	+3	3/0 × 4P	2 - 4/0 × 4P (35 - 95 × 4P)	4/0 × 4P (95 × 4P)	-	M12 	35 (310)
		1/0	1/0 - 300 (50 - 150)	-	-	M12 	32 - 40 (283 - 354)
4568	R/L1, S/L2, T/L3	250 × 4P	2/0 - 300 × 4P (70 - 150 × 4P)	250 - 300 × 4P (120 - 150 × 4P)	-	M12 	35 (310)
	U/T1, V/T2, W/T3	4/0 × 4P	2/0 - 300 × 4P (70 - 150 × 4P)	250 - 300 × 4P (120 - 150 × 4P)	-	M12 	35 (310)
	-, +1	300 × 4P	3/0 - 400 × 4P (95 - 185 × 4P)	300 - 400 × 4P (150 - 185 × 4P)	-	M12 	35 (310)
	+3	3/0 × 4P	2 - 4/0 × 4P (35 - 95 × 4P)	4/0 × 4P (95 × 4P)	-	M12 	35 (310)
		2/0	2/0 - 300 (70 - 150)	-	-	M12 	32 - 40 (283 - 354)
4605	R/L1, S/L2, T/L3	300 × 4P	2/0 - 300 × 4P (70 - 150 × 4P)	250 - 300 × 4P (120 - 150 × 4P)	-	M12 	35 (310)
	U/T1, V/T2, W/T3	300 × 4P	2/0 - 300 × 4P (70 - 150 × 4P)	250 - 300 × 4P (120 - 150 × 4P)	-	M12 	35 (310)
	-, +1	400 × 4P	3/0 - 400 × 4P (95 - 185 × 4P)	300 - 400 × 4P (150 - 185 × 4P)	-	M12 	35 (310)
	+3	4/0 × 4P	2 - 4/0 × 4P (35 - 95 × 4P)	4/0 × 4P (95 × 4P)	-	M12 	35 (310)
		2/0	2/0 - 300 (70 - 150)	-	-	M12 	32 - 40 (283 - 354)
4720	R/L1, S/L2, T/L3	300 × 4P	2/0 - 300 × 4P (70 - 150 × 4P)	250 - 300 × 4P (120 - 150 × 4P)	-	M12 	35 (310)
	U/T1, V/T2, W/T3	300 × 4P	2/0 - 300 × 4P (70 - 150 × 4P)	250 - 300 × 4P (120 - 150 × 4P)	-	M12 	35 (310)
	-, +1	400 × 4P	3/0 - 400 × 4P (95 - 185 × 4P)	300 - 400 × 4P (150 - 185 × 4P)	-	M12 	35 (310)
	+3	4/0 × 4P	2 - 4/0 × 4P (35 - 95 × 4P)	4/0 × 4P (95 × 4P)	-	M12 	35 (310)
		2/0	2/0 - 300 (70 - 150)	-	-	M12 	32 - 40 (283 - 354)

- \*1 For IP20 protection, use wires that are in the range of applicable gauges.
- \*2 Remove insulation from the ends of wires to expose the length of wire shown.
- \*3 For wire gauges more than AWG 8, tighten to a tightening torque of 4.1 N·m to 4.5 N·m (36 lbf·in to 40 lbf·in).
- \*4 Terminals - and +1 have two screws. The Recommended Gauge is the wire gauge for one terminal.
- \*5 A junction terminal is necessary to connect a braking resistor unit (LKEB-series) to terminals B1 and B2.

## ◆ Main Circuit Terminal Block Wiring Procedure

**⚠ DANGER** *Electrical Shock Hazard. Do not examine, connect, or disconnect wiring on an energized drive. Before servicing, disconnect all power to the equipment and wait for the time specified on the warning label at a minimum. The internal capacitor stays charged after the drive is de-energized. The charge indicator LED extinguishes when the DC bus voltage decreases below 50 Vdc. When all indicators are OFF, remove the covers before measuring for dangerous voltages to make sure that the drive is safe. If you do work on the drive when it is energized, it will cause serious injury or death from electrical shock.*



The procedures to wire the main circuit terminal block are different for different drive models. Refer to [Table 7.2](#) for procedures by drive model.

**Table 7.2 Types of Wiring Procedure for the Main Circuit Terminal Block**

Model	Procedure	Ref.
2004 - 2211 4002 - 4168	Procedure A	41
2257 - 2415 4208 - 4720	Procedure B	43

## ■ Wire the Main Circuit Terminal Block with Procedure A

### Notes on Wiring the Main Circuit Terminal Block

Read these notes before you wire the main circuit terminal block.

- Use UL-Listed, vinyl-coated insulated copper wires for operation with a continuous maximum permitted temperature of 75 °C at 600 V.
- Remove all unwanted objects that are near the terminal block connections.
- Remove the insulation from the connection wires to the wire stripping lengths shown in the manual.
- Do not use bent or crushed wires. Remove the damaged end of the wire before you use it. Incorrect connections can cause death or serious injury from fire.
- Do not solder stranded wire. Soldered wire connections can become loose over time and cause unsatisfactory drive performance.
- If you use stranded wire, make sure that all of the wire strands are in the connection. Also, do not twist the stranded wire too much. Incorrect connections can cause death or serious injury from fire.
- Put the wire all the way into the terminal block. Remove the insulation from the wire to the recommended wire stripping length to fit the wire with insulation in the plastic housing.
- Use a torque driver, torque ratchet, or torque wrench for the screws. A slotted driver or a hex tool will be necessary to wire the screw clamp terminal. Use applicable tools as specified by the recommended conditions in the product manual.
- If you use power tools to tighten the terminal screws, use a low speed setting (300 to 400 r/min). Failure to obey can cause damage to the terminal screws.
- Users can purchase wiring tools from Yaskawa. Contact Yaskawa or your nearest sales representative for more information.
- Wire gauges on existing drive models to be replaced may not match wire gauge ranges on new drives. Contact Yaskawa or your nearest sales representative for more information about the connection procedures.
- Do not tighten the terminal screws at an angle of 5 degrees or more. Failure to obey can cause damage to the terminal screws.
- If you damage a terminal screw, contact Yaskawa or your nearest sales representative.

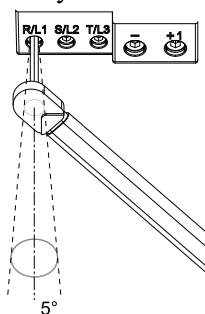

**Figure 7.3 Permitted Angle**

- Put the bit all the way into the hex socket to tighten the hex socket cap screw.
- When you tighten slotted screws, hold the straight-edge screwdriver perpendicularly to the screw. Make sure that you align the end of the straight-edge screwdriver with the screw groove.

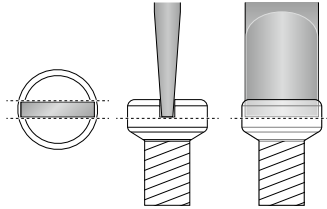

**Figure 7.4 Tightening Slotted Screws**

- After you connect the wires to the terminal block, lightly pull on the wires to make sure that they do not come out of the terminals.
- Remove the correct section of the wiring cover to make wiring easier.
- Do not let strain on the wiring cause damage. Use a strain relief near the wiring to release the tension. Refer to [Figure 7.5](#) for an example.

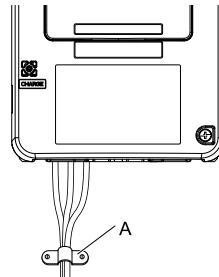

**A - Cable clamp**

**Figure 7.5 Strain Relief Example**

**Table 7.3 Recommended Wiring Tools**

Screw Size	Screw Shape	Adapter	Bit		Torque Driver Model (Tightening Torque)	Torque Wrench
			Model	Manufacturer		
M4	⊖	Bit	SF-BIT-SL 1,0X4,0-70	PHOENIX CONTACT	TSD-M 3NM (1.2 - 3 N·m (10.6 - 26.6 lbf·in))	-
M5 *1	⊖	Bit	SF-BIT-SL 1,2X6,5-70	PHOENIX CONTACT	Wire Gauge ≤ 25 mm <sup>2</sup> (AWG 10): TSD-M 3NM (1.2 - 3 N·m (10.6 - 26.6 lbf·in))	Wire Gauge ≤ 25 mm <sup>2</sup> (AWG 10): -
					Wire Gauge ≥ 30 mm <sup>2</sup> (AWG 8): -	Wire Gauge ≥ 30 mm <sup>2</sup> (AWG 8): 4.1 - 4.5 N·m (36.3 - 39.8 lbf·in) *2 *3
M6	⊕	Bit	SF-BIT-HEX 5-50	PHOENIX CONTACT	-	5 - 9 N·m (44.3 - 79.9 lbf·in) *2 *3
	⊖	Bit	SF-BIT-SL 1,2X6,5-70	PHOENIX CONTACT	-	3 - 3.5 N·m (26.6 - 31.0 lbf·in) *2 *3
M8	⊕	Bit	SF-BIT-HEX 6-50	PHOENIX CONTACT	-	8 - 12 N·m (70.8 - 106.2 lbf·in) *2 *3
M10	⊕	Bit	SF-BIT-HEX 8-50	PHOENIX CONTACT	-	12 - 14 N·m (106.2 - 123.9 lbf·in) *2 *3

\*1 When wiring drive models 2056, 4089, and smaller, select the correct tools for the wire gauge.

\*2 Use 6.35 mm (0.25 in) bit socket holder.

\*3 Use a torque wrench that can apply this torque measurement range.

## Main Circuit Terminal Block Wiring Procedure

**⚠ DANGER** *Electrical Shock Hazard. Do not examine, connect, or disconnect wiring on an energized drive. Before servicing, disconnect all power to the equipment and wait for the time specified on the warning label at a minimum. The internal capacitor stays charged after the drive is de-energized. The charge indicator LED extinguishes when the DC bus voltage decreases below 50 Vdc. When all indicators are OFF, remove the covers before measuring for dangerous voltages to make sure that the drive is safe. If you do work on the drive when it is energized, it will cause serious injury or death from electrical shock.*

The procedures to wire the main circuit terminal block are different for different drive models. Refer to [Table 7.4](#) for procedures by drive model.

**Table 7.4 Types of Wiring Procedure for the Main Circuit Terminal Block**

Model	Procedure	Ref.
2004 - 2211 4002 - 4168	Procedure A	41
2257 - 2415 4208 - 4720	Procedure B	43

## ■ Wire the Main Circuit Terminal Block with Procedure B

### Notes on Wiring the Main Circuit Terminal Block

**Note:**

- After the wiring, do not twist or shake the electrical wires too much.
- Be sure to use only wires with the correct size, stripped wire length, and tightening torque as specified by Yaskawa.
- Use tools that fit the shape of the screw head to tighten and loosen the terminal block screws.
- Make sure that there are no loose stranded wires or frayed wires after wiring is complete.

### Main Circuit Terminal Block Wiring Procedure

Remove the terminal cover before wiring the main circuit terminal block.

1. Remove the screws on the terminal block cover and pull the terminal block cover away from the drive. Pull the wiring cover away from the drive to remove the wiring cover after removing the terminal block cover.

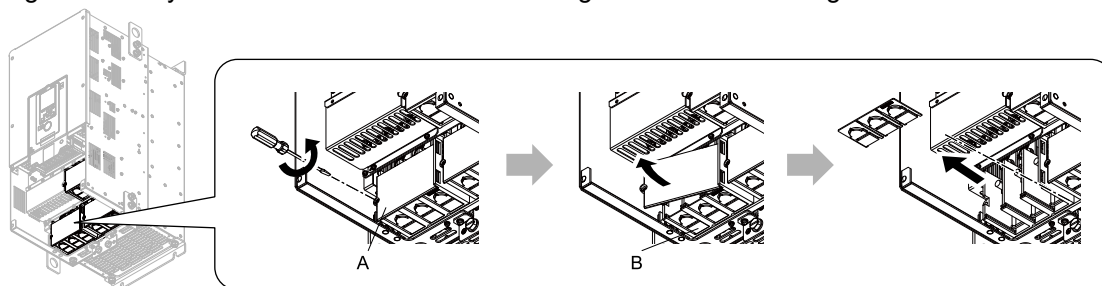

**A - Terminal block cover**

**B - Wiring cover**

**Figure 7.6 Remove the Wiring Cover**

2. Remove the terminal block nut.

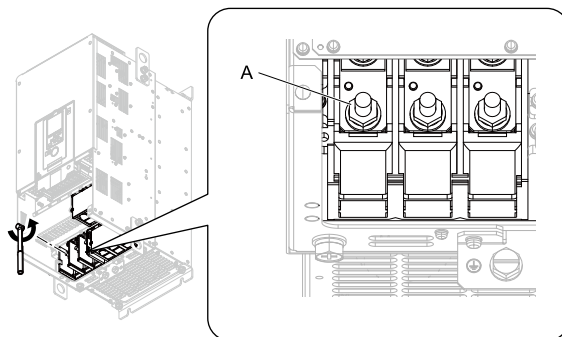

**A - Nut**

**Figure 7.7 Remove the Terminal Block Nut**

3. Wire the closed-loop crimp terminal to the main circuit terminal block.

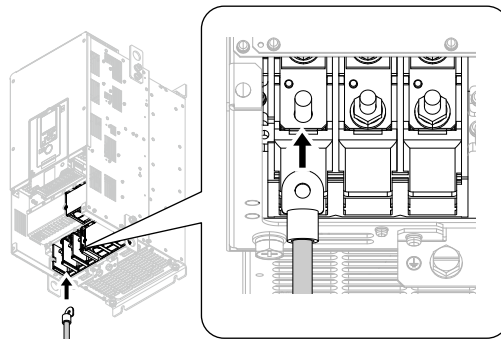

Figure 7.8 Install the Electrical Wire

4. Tighten the nut to the specified torque.

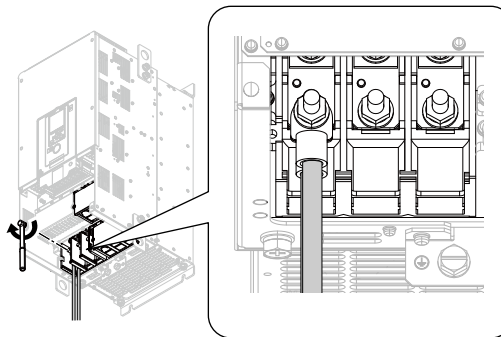
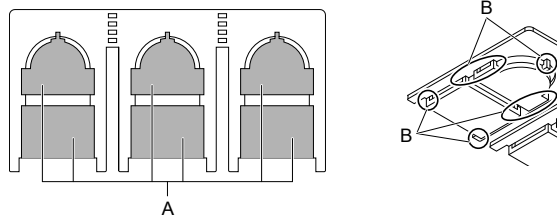

Figure 7.9 Tighten the Terminal Block Nut

5. Check the signal from the wired terminal and use a diagonal-cutting pliers to remove areas of the wiring cover cutaway section.  
Cut the areas shown in [Figure 7.10](#).



A - Cutaway section

B - Use a diagonal-cutting pliers to clip this area.

Figure 7.10 Clip the Cutaway Section of the Wiring Cover

**Note:**

- Different drive models have different wiring covers.
- Remove only the areas from the wiring cover that apply to the wired terminal. If you remove areas that do not apply to the wired terminal, the drive will not keep its IP20 protective level.
- Make sure that you hold the cutaway section tightly when you remove pieces of the cutaway section. Pieces of the cutaway section can fly out and cause injury.
- Remove sharp edges from the wiring cover cutaway section to prevent damage to the wires.
- If you use the wiring cover correctly, but you use wires that are not specified by Yaskawa, the drive will not necessarily keep its IP20 protective level.
- When you use the recommended gauge for the electrical wires, it is not necessary to attach the wiring cover of the main circuit power input terminal and the drive output terminal. If you use the applicable gauge for the electrical wires, you must attach the wiring cover.

- Attach the wiring cover and terminal block cover to their initial positions and tighten the screws on the terminal block cover.

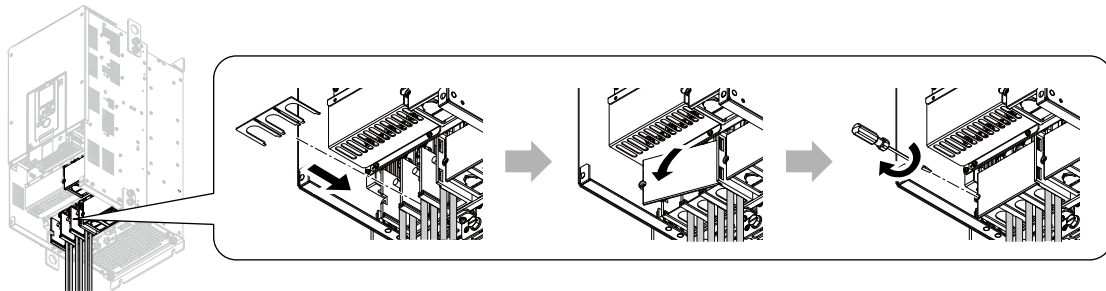

Figure 7.11 Reattach the Wiring Cover

- Put the terminal cover back in its initial position.

## 8 Keypad: Names and Functions

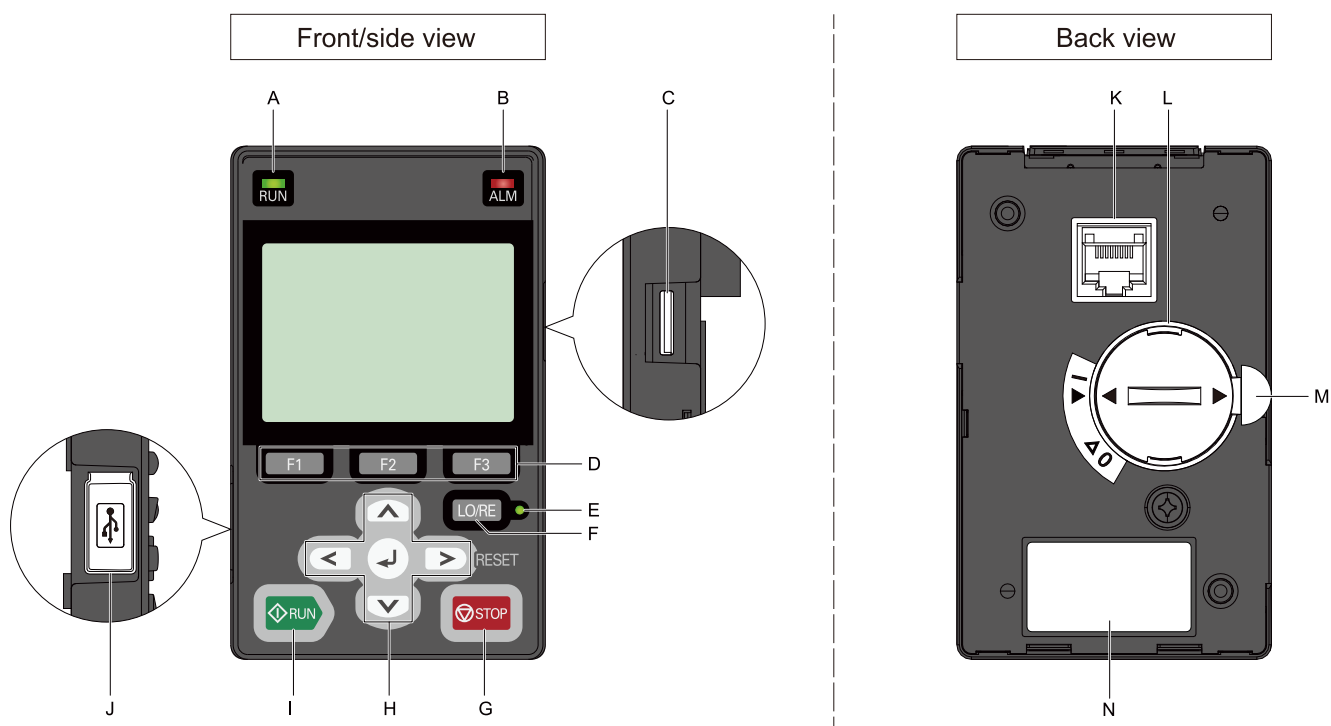

















Figure 8.1 Keypad

**Table 8.1 Keypad Components and Functions**

Symbol	Name	Function
A	<p>RUN LED</p> 	<p>Illuminates to show that the drive is operating the motor. The LED turns OFF when the drive stops.</p> <p>Flashes to show that:</p> <ul style="list-style-type: none"> <li>The drive is decelerating to stop.</li> <li>The drive received a Run command with a frequency reference of 0 Hz, but the drive is not set for zero speed control.</li> </ul> <p>Flashes quickly to show that:</p> <ul style="list-style-type: none"> <li>The drive received a Run command from the MFDI terminals and is switching to REMOTE Mode while the drive is in LOCAL Mode.</li> <li>The drive received a Run command from the MFDI terminals when the drive is not in Drive Mode.</li> <li>The drive received a Fast Stop command.</li> <li>The safety function shut off the drive output.</li> </ul> <ul style="list-style-type: none"> <li>You pushed  on the keypad while the drive is operating in REMOTE Mode.</li> <li>The drive is energized with an active Run command and <math>b1-17 = 0</math> [Run Command at Power Up = Disregard Existing RUN Command].</li> </ul>
B	<p>ALM LED</p> 	<p>Illuminates when the drive detects a fault.</p> <p>Flashes when the drive detects:</p> <ul style="list-style-type: none"> <li>Alarm</li> <li>Operation Errors</li> <li>A fault or alarm during Auto-Tuning</li> </ul> <p>The light turns off during regular drive operation. There are no alarms or faults.</p>
C	microSD Card Slot	The insertion point for a microSD card.
D	<p>Function Keys F1, F2, F3</p> 	<p>The menu shown on the keypad sets the functions for function keys. The name of each function is in the lower half of the display window.</p>
E	<p>LO/RE LED</p> 	<p>Illuminated: The keypad controls the Run command (LOCAL Mode). OFF: The control circuit terminal or serial transmission device controls the Run command (REMOTE Mode).</p> <p><b>Note:</b></p> <ul style="list-style-type: none"> <li>LOCAL: Use the keypad to operate the drive. Use the keypad to enter Run/Stop commands and the frequency reference command.</li> <li>REMOTE: Use the control circuit terminals or serial transmission to operate the drive. Use the frequency reference source entered in <math>b1-01</math> and the Run command source selected in <math>b1-02</math>.</li> </ul>
F	<p>LO/RE Selection Key</p> 	<p>Switches drive control for the Run command and frequency reference between the keypad (LOCAL) and an external source (REMOTE).</p> <p><b>Note:</b></p> <ul style="list-style-type: none"> <li>The LOCAL/REMOTE Selection Key continuously stays enabled after the drive stops in Drive Mode. If the application must not switch from REMOTE to LOCAL because it will have a negative effect on system performance, set <math>a2-01 = 0</math> [LO/RE Key Function Selection = Disabled] to disable .</li> <li>The drive will not switch between LOCAL and REMOTE when it is receiving a Run command from an external source.</li> </ul>
G	<p>STOP Key</p> 	<p>Stops drive operation.</p> <p><b>Note:</b></p> <p>Push  to stop the motor. This will also apply when a Run command (REMOTE Mode) is active at an external Run command source. To disable  priority, set <math>a2-02 = 0</math> [STOP Key Function Selection = Disabled].</p>
H	<p>Left Arrow Key</p> 	<ul style="list-style-type: none"> <li>Moves the cursor to the left.</li> <li>Goes back to the previous screen.</li> </ul>
	<p>Up Arrow Key/Down Arrow Key</p> 	<ul style="list-style-type: none"> <li>Scrolls up or down to show the next item or the previous item.</li> <li>Selects parameter numbers, and increments or decrements setting values.</li> </ul>
	<p>Right Arrow Key (RESET)</p> 	<ul style="list-style-type: none"> <li>Moves the cursor to the right.</li> <li>Continues to the next screen.</li> <li>Resets the drive to clear a fault.</li> </ul>
	<p>ENTER Key</p> 	<ul style="list-style-type: none"> <li>Enters parameter values and settings.</li> <li>Selects menu items to move between keypad displays.</li> <li>Selects each mode, parameter, and set value.</li> </ul>
I	<p>RUN Key</p> 	<p>Starts the drive in LOCAL Mode. Starts the operation in Auto-Tuning Mode.</p> <p><b>Note:</b></p> <p>Before you use the keypad to operate the motor, push  on the keypad to set the drive to LOCAL Mode.</p>
J	USB Terminal	For factory adjustment
K	RJ-45 Connector	Connects to the drive using an RJ-45 8-pin straight through UTP CAT5e extension cable or keypad connector.

Symbol	Name	Function
L	Clock Battery Cover	Remove this cover to install or replace the clock battery. <b>Note:</b> <ul style="list-style-type: none"> <li>The battery included with the keypad is for operation check. It may be exhausted earlier than the expected battery life described in the manual.</li> <li>Refer to "Maintenance &amp; Troubleshooting Manual (TOEPAIGA8001)" for details on replacement procedure.</li> </ul> To replace the battery, use a Hitachi Maxell "CR2016 Lithium Manganese Dioxide Lithium Battery" or an equivalent battery with these properties: <ul style="list-style-type: none"> <li>Nominal voltage: 3 V</li> <li>Operating temperature range: -20 °C to +85 °C (-4 °F to +185 °F)</li> </ul>
M	Insulation Sheet	An insulating sheet is attached to the keypad battery to prevent battery drain. Remove the insulation sheet before you use the keypad for the first time.
N	Nameplate	Shows the model number of the keypad and other information <b>Note:</b> <ul style="list-style-type: none"> <li>"REV" identifies the hardware and software version of the keypad.</li> <li>"FLASH" identifies the version of the flash memory.</li> </ul>

**⚠ WARNING** *Sudden Movement Hazard. If you change the control source when b1-07 = 1 [LOCAL/REMOTE Run Selection = Accept Existing RUN Command], the drive can start suddenly. Before you change the control source, remove all personnel from the area around the drive, motor, and load. Sudden starts can cause serious injury or death.*

### ◆ Keypad Mode and Menu Displays

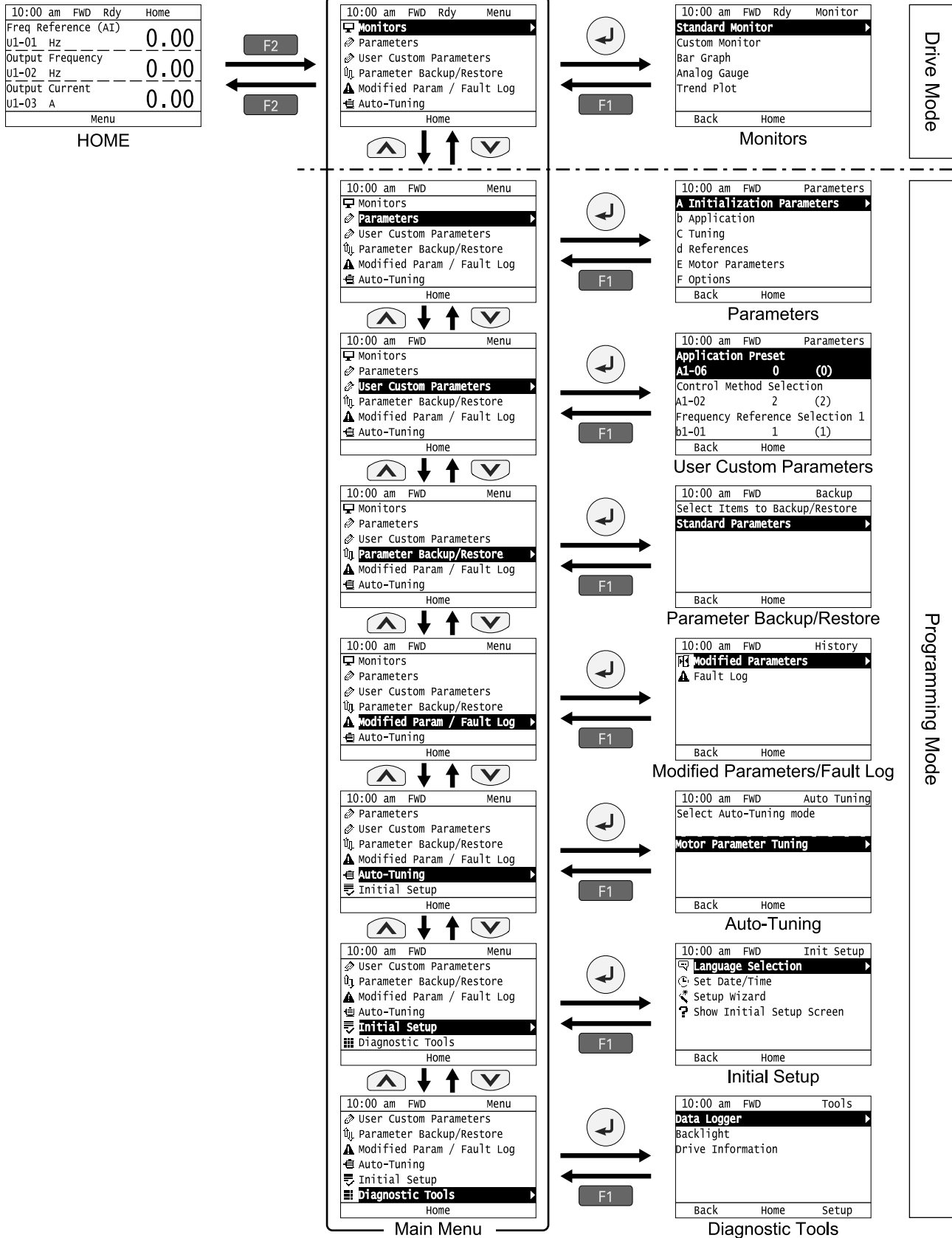



Figure 8.2 Keypad Functions and Display Levels



**Note:**

- Energize the drive with factory defaults to show the Initial Setup screen. Push **F2** [Home] to show the HOME screen.
  - Select [No] from the [Show Initial Setup Screen] setting to not display the Initial Setup screen.
- Push  from the Home screen to show drive monitors.
- Push  to set *d1-01 [Reference 1]* when the Home screen shows *U1-01 [Frequency Reference]* in LOCAL Mode.
- The keypad will show [Rdy] when the drive is in Drive Mode. The drive is prepared to accept a Run command.
- Set *b1-08 [Run Command Select in PRG Mode]* to accept or reject a Run command from an external source while in Programming Mode.
  - Set *b1-08 = 0 [Disregard RUN while Programming]* to reject the Run command from an external source while in Programming Mode (default).
  - Set *b1-08 = 1 [Accept RUN while Programming]* to accept the Run command from an external source while in Programming Mode.
  - Set *b1-08 = 2 [Allow Programming Only at Stop]* to prevent changes from Drive Mode to Programming Mode while the drive is operating.

**Table 8.2 Drive Mode Screens and Functions**

Mode	Keypad Screen	Function
Drive Mode	Monitors	Sets monitor items to display.
Programming Mode	Parameters	Changes parameter settings.
	User Custom Parameters	Shows the User Parameters.
	Parameter Backup/Restore	Saves parameters to the keypad as backup.
	Modified Parameters/Fault Log	Shows modified parameters and fault history.
	Auto-Tuning	Auto-Tunes the drive.
	Initial Setup Screen	Changes initial settings.
	Diagnostic Tools	Sets data logs and backlight.

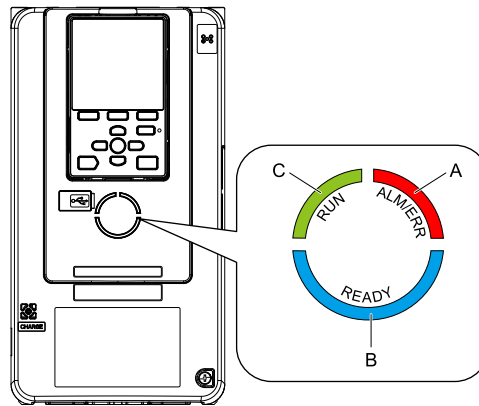

## 9 LED Status Ring

The LED Status Ring on the drive cover shows the drive operating status.



**A - ALM/ERR**  
**B - Ready**

**C - RUN**

LED	Status	Description	
A	ALM/ERR	Illuminated	The drive detects a fault.
		Flashing <sup>*1</sup>	The drive detects: <ul style="list-style-type: none"> <li>An alarm</li> <li>An oPE parameter setting error</li> <li>An Auto-Tuning error</li> </ul> <b>Note:</b> The LED will illuminate to identify a fault if the drive detects a fault and an alarm at the same time.
		OFF	There are no drive faults or alarms.
B	Ready	Illuminated	The drive is operating or is prepared for operation.
		Flashing <sup>*1</sup>	The drive is in <i>STo</i> [ <i>Safe Torque OFF</i> ] condition.
		Flashing Quickly <sup>*1</sup>	The voltage of the main circuit power supply dropped, and only the external 24 V power supply provides the power to the drive.
		OFF	<ul style="list-style-type: none"> <li>The drive detects a fault.</li> <li>There is no fault and the drive received a Run command, but the drive cannot operate. For example, in Programming Mode or when  is flashing.</li> </ul>
C	RUN	Illuminated	The drive is in regular operation.
		Flashing <sup>*1</sup>	<ul style="list-style-type: none"> <li>The drive is decelerating to stop.</li> <li>The drive received a Run command with a frequency reference of 0 Hz, but the drive is not set for zero speed control.</li> <li>The drive received a DC Injection Braking command.</li> </ul>
		Flashing Quickly <sup>*1</sup>	<ul style="list-style-type: none"> <li>The drive received a Run command from the MFDI terminals and is switching to REMOTE Mode while the drive is in LOCAL Mode.</li> <li>The drive received a Run command from the MFDI terminals when the drive is not in Drive Mode.</li> <li>The drive received a Fast Stop command.</li> <li>The safety function shuts off the drive output.</li> <li>The user pushed  on the keypad while the drive is operating in REMOTE Mode.</li> <li>The drive is energized with an active Run command and <i>b1-17 = 0</i> [<i>Run Command at Power Up = Disregard Existing RUN Command</i>].</li> <li>The drive is set to coast-to-stop with timer (<i>b1-03 = 3</i> [<i>Stopping Method Selection = Coast to Stop with Timer</i>]), and the Run command is disabled then enabled during the Run wait time.</li> </ul>
		OFF	The motor is stopped.
		OFF	The motor is stopped.

\*1 Refer to Figure 9.1 for the difference between “flashing” and “flashing quickly”.

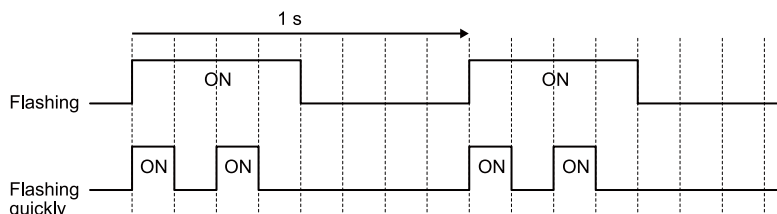

Figure 9.1 LED Flashing Statuses

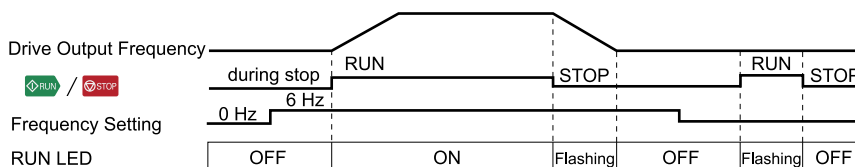

Figure 9.2 Relation between RUN LED and Drive Operation

## 10 Drive Start-Up

1. Install and wire the drive.
2. Energize the drive.
3. Run the Setup Wizard to automatically set these functions:
  - Control Method Selection
  - HD/ND selection
  - Motor data
  - Frequency Reference
  - Run command source
  - Acceleration and Deceleration Times
4. Use *A1-06 [Application Preset]* to initialize the drive for a special application if necessary.
5. Run the motor without a load.
6. Make sure that the drive is operating correctly and make sure that the host controller is sending commands to the drive.
7. Connect the load.
8. Run the motor.
9. Make sure that the drive is operating correctly.
10. Fine-tune and set application parameters, such as PID.
11. Do a final operation check and make sure that parameter settings are correct.

The drive is prepared to run the operation.

### ◆ Setup Wizard

Refer to the motor nameplate and record the information in this table before you energize the drive.

Item	Value
Motor Rated Power	kW
Motor Rated Voltage	V
Motor Rated Current (FLA)	A
Motor Rated Frequency	Hz
Motor Maximum Frequency	Hz
Motor Pole Count	Number of Motor Poles

Item	Value
Motor Base Rotation Speed	min <sup>-1</sup> (r/min)
Number of Motor Encoder Pulses	ppr

The drive setup wizard prepares the drive for operation. Use the information from the table to do Auto-Tuning and test runs.

1. Energize the drive to show the initial setup screen.

**Note:**

If the keypad does not show the Initial Setup screen, push **F2** (Menu) to show the Menu screen then push **▲** to select [Initial Setup].

2. Select [Set Date/Time] to set the date and time.

**Note:**

Open the clock battery cover and put in a battery to use the clock functions. Use a Hitachi Maxell CR2016 manganese dioxide lithium battery or an equivalent battery with these properties:

- Nominal voltage: 3 V
- Operating temperature range: -20°C to +85°C (-4°F to +185°F)
- Nominal battery life: 2 years (20°C (68°F) ambient temperature)

3. Select [Setup Wizard] and follow the instructions shown on the keypad.

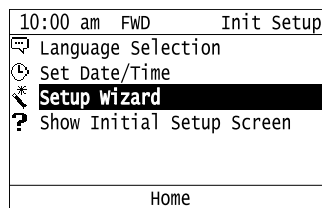

When you finish Setup Wizard, the drive and motor are ready for operation.

**Note:**

Refer to [Disable the Initial Setup Screen on page 54](#) if you do not want to show the initial setup screen when you energize the drive.

### ◆ Change Parameter Setting Values

This example shows how to change the setting value for *C1-01 [Acceleration Time 1]*. Do the steps in this procedure to set parameters for the application.

1. Push **F2** (Home) to show the HOME screen.

**Note:**

- When the drive is in HOME Mode, the screen shows [Home] in the upper right-hand corner of the screen.
- If [Home] is not shown above the **F2**, push **F1** (Back).

2. Push **F2** (Menu).

10:00 am FWD Rdy	Home
Freq Reference (AI)	
U1-01 Hz	0.00
Output Frequency	
U1-02 Hz	0.00
Output Current	
U1-03 A	0.00
Menu	

3. Push  or  to select [Parameters], then push .



10:00 am	FWD	Menu
Monitors		
Parameters		
User Custom Parameters		
Parameter Backup/Restore		
Modified Param / Fault Log		
Auto-Tuning		
Home		

4. Push  or  to select [C Tuning], then push .





10:00 am	FWD	Parameters
A Initialization Parameters		
b Application		
C Tuning		
d References		
E Motor Parameters		
F Options		
Back		Home

5. Push  or  to select [C1 Accel & Decel Time], then push .



10:00 am	FWD	Parameters
C1 Accel & Decel Time		
C2 S-Curve Characteristics		
C3 Slip Compensation		
C4 Torque Compensation		
C6 Duty & Carrier Frequency		
Back		Home

6. Push  or  to select C1-01, then push .

10:00 am	FWD	Parameters
Acceleration Time 1		
C1-01	10.0	(10.0)sec
Deceleration Time 1		
C1-02	10.0	(10.0)sec
Acceleration Time 2		
C1-03	10.0	(10.0)sec
Back		Home

7. Push  or  to select the specified digit, then push  or  to select the correct number.

10:00 am	FWD	Parameters
Acceleration Time 1		
C1-01	0010.0sec	
Default : 10.0sec		
Range : 0.0~6000.0		
Back		Default Min/Max

- Push  (Default) to set the parameter to factory default.
- Push  (Min/Max) to show the minimum value or the maximum value on the display.

8. Push  to keep the changes.

10:00 am	FWD	Parameters
Acceleration Time 1		
C1-01	0020.0 sec	
Default : 10.0 sec		
Range : 0.0~6000.0		
Back		Default Min/Max

9. Continue to change parameters, then push  (Back),  (Home) to go back to the home screen after you change all the applicable parameters.

## ◆ Disable the Initial Setup Screen

Do the steps in this procedure to not show the initial start-up screen when the drive is energized.

1. Push **F2** (Home) to show the HOME screen.

**Note:**

- When the drive is in HOME Mode, the screen shows [Home] in the upper right-hand corner of the screen.
- If the screen does not show [Home] for **F2**, push **F1** (Back), and then push **F2** to show [Home].

2. Push **F2** (Menu).

10:00 am	FWD	Rdy	Home
Freq Reference (AI)			
U1-01	Hz		0.00
Output Frequency			
U1-02	Hz		0.00
Output Current			
U1-03	A		0.00
Menu			

3. Push **▲** / **▼** to select [Initial Setup], then push **↵**.

10:00 am	FWD	Menu
User Custom Parameters		
Parameter Backup/Restore		
Modified Param / Fault Log		
Auto-Tuning		
<b>Initial Setup</b>		
Diagnostic Tools		
Home		

4. Push **▲** / **▼** to select [Show Initial Setup Screen], then push **↵**.

10:00 am	FWD	Init Setup
Language Selection		
Set Date/Time		
Setup Wizard		
<b>Show Initial Setup Screen</b>		
Back		
Home		

5. Push **▲** / **▼** to select [No], then push **↵**.

10:00 am	FWD	Init Setup
Show Initial Setup Screen		
No		
<b>Yes</b>		
Back		
Home		

- [No]: The keypad will not show the Initial Setup Screen when the drive is energized.
- [Yes]: The keypad will show the Initial Setup Screen when the drive is energized.

## ◆ Control Circuit Terminal Block Functions

*Hx-xx* parameters set functions for the multi-function input and output terminals.

**⚠ WARNING** Sudden Movement Hazard. Correctly wire and test all control circuits to make sure that the control circuits operate correctly. If you use a drive that has incorrect control circuit wiring or operation, it can cause death or serious injury.

**⚠ WARNING** Sudden Movement Hazard. Check the I/O signals and the external sequences for the drive before you set the Application Preset function. When you set the Application Preset function (A1-06 ≠ 0), it changes the I/O terminal functions for the drive and it can cause equipment to operate unusually. This can cause serious injury or death.

**NOTICE** Damage to Equipment. Do not energize and de-energize the drive more frequently than one time each 30 minutes. If you frequently energize and de-energize the drive, it can cause drive failure.

## ■ Input Terminals

Refer to [Table 10.1](#) for a list of input terminals and functions.

**Table 10.1 Multi-function Input Terminals**

Type	Terminal	Name (Default)	Function (Signal Level)	
Digital Inputs	S1	MFDI selection 1 (ON: Forward run OFF: Stop)	<ul style="list-style-type: none"> <li>• Photocoupler</li> <li>• 24 V, 6 mA</li> </ul> <p><b>Note:</b> Install the wire jumpers between terminals SC-SP and SC-SN to set the MFDI power supply (sinking/sourcing mode or internal/external power supply).</p> <ul style="list-style-type: none"> <li>• Sinking Mode: Install a jumper between terminals SC and SP.</li> </ul> <p><b>NOTICE</b> <i>Damage to Equipment. Do not close the circuit between terminals SC-SN. If you close the circuits between terminals SC-SP and terminals SC-SN at the same time, it will cause damage to the drive.</i></p> <ul style="list-style-type: none"> <li>• Sourcing Mode: Install a jumper between terminals SC and SN.</li> </ul> <p><b>NOTICE</b> <i>Damage to Equipment. Do not close the circuit between terminals SC-SP. If you close the circuits between terminals SC-SP and terminals SC-SN at the same time, it will cause damage to the drive.</i></p> <ul style="list-style-type: none"> <li>• External power supply: No jumper necessary between terminals SC-SN and terminals SC-SP.</li> </ul>	
	S2	MFDI selection 2 (ON: Reverse run OFF: Stop)		
	S3	MFDI selection 3 (External fault (N.O.))		
	S4	MFDI selection 4 (Fault reset)		
	S5	MFDI selection 5 (Multi-step speed reference 1)		
	S6	MFDI selection 6 (Multi-step speed reference 2)		
	S7	MFDI selection 7 (Jog command)		
	S8	MFDI selection 8 (Baseblock command (N.O.))		
	SN	MFDI power supply 0 V		MFDI power supply, 24 V (maximum 150 mA)
	SC	MFDI selection common		<b>NOTICE</b> <i>Damage to Equipment. Do not close the circuit between terminals SP-SN. If you close the circuits between terminals SC-SP and terminals SC-SN at the same time, it will cause damage to the drive.</i>
SP	MFDI power supply +24 Vdc			
Safe Disable Input	H1	Safe Disable input 1	<p>Remove the jumper between terminals H1-HC and H2-HC to use the Safe Disable input.</p> <ul style="list-style-type: none"> <li>• 24 V, 6 mA</li> <li>• ON: Normal operation</li> <li>• OFF: Coasting motor</li> <li>• Internal impedance 4.7 kΩ</li> <li>• OFF Minimum OFF time of 2 ms.</li> </ul> <p>Safe Disable function common</p> <p><b>NOTICE</b> <i>Do not close the circuit between terminals HC and SN. A closed circuit between these terminals will cause damage to the drive.</i></p>	
	H2	Safe Disable input 2		
	HC	Safe Disable function common		

Type	Terminal	Name (Default)	Function (Signal Level)
Master Frequency Reference	RP	Master frequency reference pulse train input (Master frequency reference)	<ul style="list-style-type: none"> <li>Response frequency: 0 Hz to 32 kHz</li> <li>H level duty: 30% to 70%</li> <li>H level voltage: 3.5 V to 13.2 V</li> <li>L level voltage: 0.0 V to 0.8 V</li> <li>Input impedance: 3 kΩ</li> </ul>
	+V	Power supply for frequency setting	10.5 V (allowable current 20 mA maximum)
	-V	Power supply for frequency setting	-10.5 V (allowable current 20 mA maximum)
	A1	MFAI1 (Master frequency reference)	Voltage input or current input Select terminal A1 with DIP switch S1-1 and H3-01 [Terminal A1 Signal Level Select].
	A2	MFAI2 (Combined to terminal A1)	Select terminal A2 with DIP switch S1-2 and H3-09 [Terminal A2 Signal Level Select] <ul style="list-style-type: none"> <li>-10 V to +10 V/-100% to +100% (input impedance: 20 kΩ)</li> <li>0 V to 10 V/100% (input impedance: 20 kΩ)</li> <li>4 mA to 20 mA/100%, 0 mA to 20 mA/100% (input impedance: 250 Ω)</li> </ul>
	A3	MFAI3/PTC input (Auxiliary frequency reference)	<ul style="list-style-type: none"> <li>Voltage input or current input Select using DIP switch S1-3 and H3-05 [Terminal A3 Signal Level Select].</li> <li>-10 V to +10 V/-100% to +100% (input impedance: 20 kΩ)</li> <li>0 V to 10 V/100% (input impedance: 20 kΩ)</li> <li>4 mA to 20 mA/100%, 0 mA to 20 mA/100% (input impedance: 250 Ω)</li> <li>PTC input (Motor Overheat Protection) Set DIP switch S4 to "PTC" and set DIP switch S1-3 to "V" to set terminal A3 for PTC input.</li> </ul>
	AC	Frequency reference common	0 V
E (G)	Connecting shielded cable	-	

## ■ Output Terminals

Refer to [Table 10.2](#) and [Table 10.3](#) for a list of Output terminals and functions.

**Table 10.2 Control Circuit Output Terminals**

Type	Terminal	Name (Default)	Function (Signal Level)
Fault Relay Output	MA	N.O. output (Fault)	<ul style="list-style-type: none"> <li>Relay output</li> <li>30 Vdc, 10 mA to 1 A</li> <li>250 Vac, 10 mA to 1 A</li> <li>Minimum load: 5 V, 10 mA (Reference value)</li> </ul>
	MB	N.C. output (Fault)	
	MC	Digital output common	
MFDO	M1	MFDO (During Run)	<ul style="list-style-type: none"> <li>Relay output</li> <li>30 Vdc, 10 mA to 1 A</li> <li>250 Vac, 10 mA to 1 A</li> <li>Minimum load: 5 V, 10 mA (Reference value)</li> </ul> <p><b>Note:</b> Do not set functions that frequently switch ON/OFF to MFDO (M1 to M6) because this will decrease the performance life of the relay contacts. Yaskawa estimates switching life at 200,000 times (assumes 1 A, resistive load).</p>
	M2		
	M3	MFDO (Zero Speed)	
	M4		
	M5	MFDO (Speed Agree 1)	
	M6		

**Table 10.3 Control Circuit Monitor Output Terminals**

Type	Terminal	Name (Default)	Function (Signal Level)
Monitor Output	MP	Pulse train output (Output frequency)	32 kHz (maximum) Refer to "Pulse Train Output" (page 62) for more information.
	FM	Analog monitor output 1 (Output frequency)	Select voltage or current output. <ul style="list-style-type: none"> <li>0 V to 10 V/0% to 100%</li> <li>-10 V to +10 V/-100% to +100%</li> <li>4 mA to 20 mA (Receiver recommended impedance: 250 Ω)</li> </ul>
	AM	Analog monitor output 2 (Output current)	<p><b>Note:</b> Select with jumper switch S5 and H4-07 [Terminal FM Signal Level Select] or H4-08 [Terminal AM Signal Level Select].</p>
	AC	Monitor common	0 V



## External Power Supply Input Terminals

Refer to [Table 10.4](#) for a list of the functions of the external power supply input terminals.

**Table 10.4 External Power Supply Input Terminals**

Type	Terminal	Name (Default)	Function
External Power Supply Input Terminals	PS	External 24 V power supply input	Supplies backup power to the drive control circuit, keypad, and option board. 21.6 VDC to 26.4 VDC, 700 mA
	AC	External 24 V power supply ground	0 V

## Serial Communication Terminals

Refer to [Table 10.5](#) for a list of serial communication terminals and functions.

**Table 10.5 Serial Communication Terminals**

Type	Terminal	Terminal Name	Function (Signal Level)	
Modbus Communication	D+	Communication input/output (+)	MEMOBUS/Modbus communications Use an RS-485 cable to connect the drive.  <b>Note:</b> Set DIP switch S2 to ON to enable the termination resistor in the last drive in a MEMOBUS/Modbus network.	<ul style="list-style-type: none"> <li>RS-485</li> <li>MEMOBUS/Modbus communication protocol</li> <li>Maximum 115.2 kbps</li> </ul>
	D-	Communication output (-)		
	AC	Shield ground	0 V	

## Control Circuit Terminal Configuration

The control circuit terminals are in the positions shown in [Figure 10.1](#).

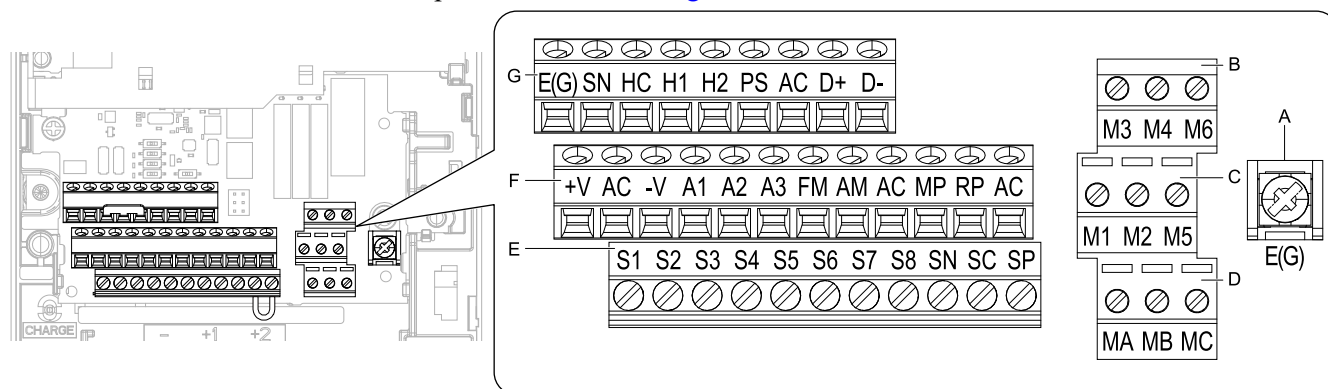

- A - Terminal block (TB5)
- B - Terminal block (TB2-3)
- C - Terminal block (TB2-2)
- D - Terminal block (TB2-1)

- E - Terminal block (TB1)
- F - Terminal block (TB3)
- G - Terminal block (TB4)

**Figure 10.1 Control Circuit Terminal Arrangement**

The tightening torque for the terminal screws is shown on the reverse side or the lower front side of the front cover.

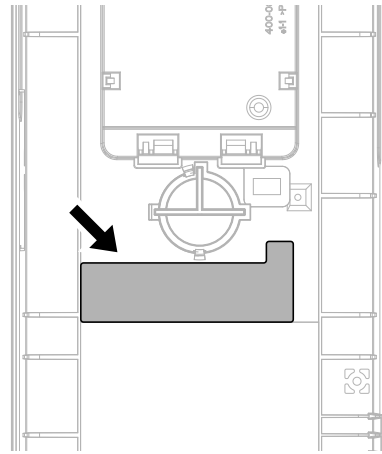

Figure 10.2 Tightening Torque Display Location (Reverse side of Front Cover)

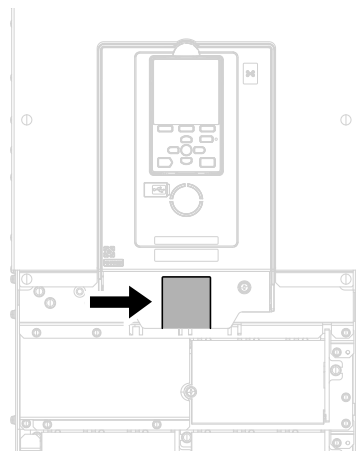

Figure 10.3 Tightening Torque Display Location (Lower Front Side of Front Cover)

### ■ Control Circuit Wire Gauges and Tightening Torques

Use the tables in this section to select the correct wires. Use shielded wire to wire the control circuit terminal block. Use crimp ferrules on the wire ends to make the wiring procedure easier and more reliable.

Table 10.6 Control Circuit Wire Gauges and Tightening Torques

Terminal Block	Terminal	Screw Size	Tightening Torque N·m (lbf·in)	Bare Wire		Crimp Ferrule	
				Recomm. Gauge mm <sup>2</sup> (AWG)	Applicable Gauge mm <sup>2</sup> (AWG)	Recomm. Gauge mm <sup>2</sup> (AWG)	Applicable Gauge mm <sup>2</sup> (AWG)
TB1	S1 - S8, SN, SC, SP	M3	0.5 - 0.6 (4.4 - 5.3)	0.75 (18)	<ul style="list-style-type: none"> <li>Stranded wire 0.2 - 1.0 (24 - 16)</li> <li>Solid wire 0.2 - 1.5 (24 - 16)</li> </ul>	0.5 (20)	0.25 - 0.5 (24 - 20)
TB2	M1 - M6, MA, MB, MC						
TB3	+V, AC, -V, A1, A2, A3, FM, AM, AC, MP, RP, AC						
TB4	E (G), SN, HC, H1, H2, PS, AC, D+, D-						
TB5	E (G)	M3.5	0.5 - 1.0 (4.4 - 8.9)	0.5 - 2 (20 - 14)	1.25 (12)	-	-

#### Crimp Ferrules

Attach an insulated sleeve when you use crimp ferrules. Refer to [Table 10.7](#) for the recommended external dimensions and model numbers of crimp ferrules.

Use the CRIMPFOX 6, a crimping tool made by PHOENIX CONTACT.

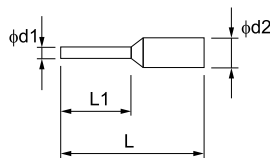

Figure 10.4 External Dimensions of Crimp Ferrules

Table 10.7 Crimp Ferrule Models and Sizes

Wire Gauge mm <sup>2</sup> (AWG)	Model	L (mm)	L1 (mm)	φd1 (mm)	φd2 (mm)
0.25 (24)	AI 0.25-8YE	12.5	8	0.8	2.0
0.34 (22)	AI 0.34-8TQ	12.5	8	0.8	2.0
0.5 (20)	AI 0.5-8WH, AI 0.5-8OG	14	8	1.1	2.5

## ◆ Wiring the Control Circuit Terminal

**⚠ WARNING** *Electrical Shock Hazard. Do not remove covers or touch circuit boards while the drive is energized. If you touch the internal components of an energized drive, it can cause serious injury or death.*

**NOTICE** *Do not let wire shields touch other signal lines or equipment. Insulate the wire shields with electrical tape or shrink tubing. If you do not insulate the wire shields, it can cause a short circuit and damage the drive.*

### Note:

- Isolate control circuit wiring from main circuit wiring (terminals R/L1, S/L2, T/L3, B1, B2, U/T1, V/T2, W/T3, -, +1, +2, +3) and other high-power wiring. If control circuit wiring is adjacent to main circuit wiring, it can cause incorrect operation of the drive and equipment from electrical interference.
- Isolate wiring for contact output terminals MA, MB, MC and M1-M6 from other control circuit wiring. If contact output terminal wiring is adjacent to other control circuit wiring, it can cause incorrect operation of the drive and equipment from electrical interference.
- Use a Class 2 power supply to connect external power to the control terminals. If the power supply for peripheral devices is incorrect, it can cause a decrease in drive performance.
- Connect the shield of shielded cable to the applicable ground terminal. Incorrect equipment grounding can cause drive or equipment malfunction from electrical interference.

Correctly ground the drive terminals and complete main circuit wiring before you wire the control circuit. Remove the keypad and front cover.

1. Push in on the tabs on the both sides of the LED status ring board to release the board from the bracket. Pull the board forward to remove it.

**NOTICE** *When you remove the LED Status Board from the drive bracket, make sure that you temporarily install it in the holding position provided on the drive. If you cause damage to the LED status ring board, the LEDs will not function correctly.*

### Note:

You can temporarily store the LED status ring board with the temporary placement holes on the drive. The location of the temporary placement holes is different on different drive models.

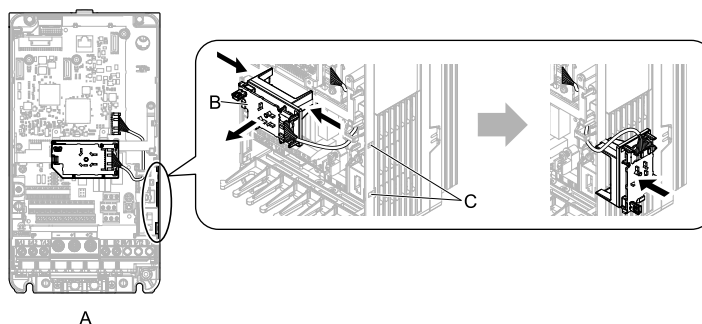

A - Drive front

B - LED status ring board

C - Temporary placement holes

Figure 10.5 Remove the LED Status Ring Board

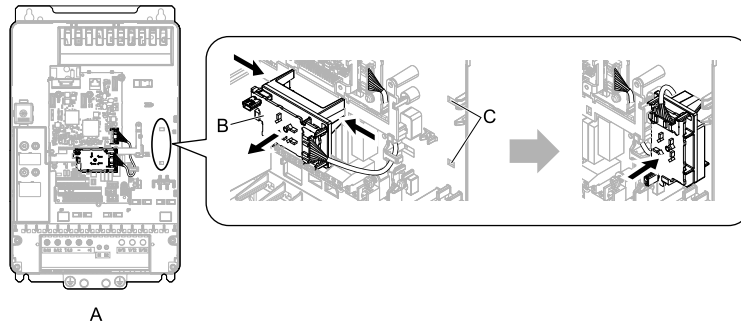

A - Drive front  
B - LED status ring board

C - Temporary placement holes

Figure 10.6 Remove the LED Status Ring Board

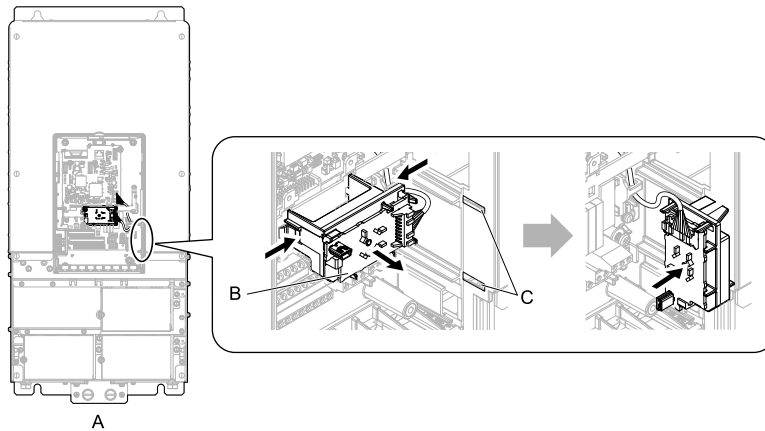

A - Drive front  
B - LED status ring board

C - Temporary placement holes

Figure 10.7 Remove the LED Status Ring Board

2. Refer to the figure and wire the control circuit.

**⚠ WARNING** *Fire Hazard. Tighten all terminal screws to the correct tightening torque. Connections that are too loose or too tight can cause incorrect operation and damage to the drive. Incorrect connections can also cause death or serious injury from fire.*

**Note:**

- Use shielded, twisted-pair wires and ground the shield to the ground terminal of the drive. Incorrect equipment grounding can cause drive or equipment malfunction from electrical interference.
- Do not use control circuit wiring that is longer than 50 m (164 ft) to supply the analog frequency reference from a remote source. If the control circuit wiring is too long, it can cause unsatisfactory system performance.

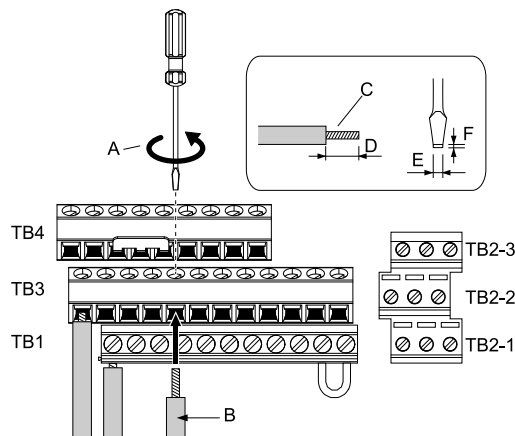

**A** - Loosen the screws and put the wire into the opening on the terminal block.

**B** - Wire with a crimp ferrule attached, or unsoldered wire with the core wires lightly twisted

**C** - Pull back the shielding and lightly twist the end with your fingers to keep the ends from fraying.

**D** - When you do not use crimp ferrules, remove approximately 5.5 mm (0.21 in) of the covering at the end of the wire.

**E** - Blade width of 2.5 mm (0.1 in) or less

**F** - Blade thickness of 0.4 mm (0.01 in) or less

**Figure 10.8** Wiring Procedure for the Control Circuit

**Note:**

- Do not solder the core wire. Soldered wiring connections can become loose and cause the drive to malfunction.
- Tighten all terminal screws to the correct tightening torque. Connections that are too loose or too tight can cause incorrect operation and damage to the drive. Incorrect connections can also cause death or serious injury from fire.
- Refer to [Figure 10.9](#) for information to prepare terminal ends of the shielded wire.
- Prepare the wire ends of shielded twisted-pair wires as shown in [Figure 10.9](#) to use an analog reference from an external frequency setting potentiometer to set the frequency. Connect the shield to terminal E (G) of the drive.

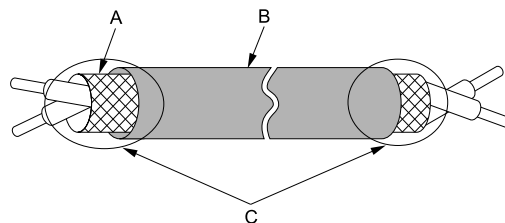

**A** - Connect the shield to terminal E (G) of the drive.

**B** - Sheath

**C** - Insulate with electrical tape or shrink tubing.

**Figure 10.9** Prepare the Ends of Shielded Wire

- Put the cable through the clearance in the wiring cover.

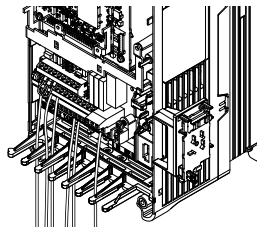

**Figure 10.10** Control Circuit Wiring

- Install the LED status ring board, front cover, and the keypad to their initial positions.

## ◆ Switches and Jumpers on the Terminal Board

The terminal board has switches to adapt the drive I/Os to the external control signals as shown in [Figure 10.11](#). Set the switches to select the functions for each terminal.

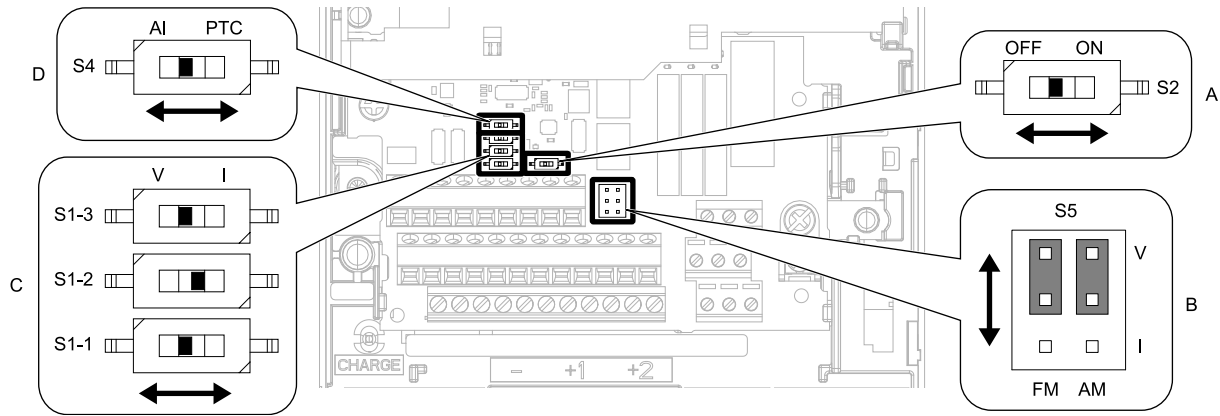

Figure 10.11 Locations of Switches

Table 10.8 I/O Terminals and Switches Functions

Position	Switch	Terminal	Function	Default
A	DIP switch S2	-	Enables and disables the MEMOBUS/Modbus communications termination resistor.	OFF
B	Jumper Switch S5	FM, AM	Sets terminals FM and AM to voltage or current output.	FM: V (voltage output) AM: V (voltage output)
C	DIP switch S1-1	A1	Sets the input signal type (voltage/current).	V (voltage input)
	DIP switch S1-2	A2	Sets the input signal type (voltage/current).	I (current input)
	DIP switch S1-3	A3	Sets the input signal type (voltage/current).	V (voltage input)
D	DIP switch S4	A3	Sets MFAI or PTC input.	AI (analog input)

### ◆ Control I/O Connections

This section gives information about the settings for the listed control circuit I/O signals.

- MFDI (terminals S1 to S8)
- Pulse train output (terminal MP)
- MFAI (terminals A1 to A3)
- PTC input (terminal A3)
- MFAO (terminals FM, AM)
- MEMOBUS/Modbus communications (terminals D+, D-, AC)

### ■ Pulse Train Output

You can use pulse train monitor output terminal MP for sourcing mode or for sinking mode.

- Use for sourcing mode  
The load impedance changes the voltage level of the pulse train output signal.

Load Impedance $R_L(k\Omega)$	Output Voltage $V_{MP}(V)$
1.5 k $\Omega$ or more	5 V or more
4.0 k $\Omega$ or more	8 V or more
10 k $\Omega$ or more	10 V or more

**Note:**

Use the formula in [Figure 10.12](#) to calculate the necessary load resistance (k $\Omega$ ) to increase output voltage  $V_{MP}(V)$ .

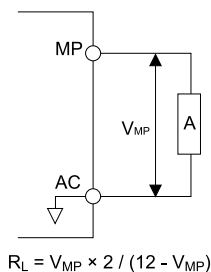

### A - Load Impedance

Figure 10.12 Wiring to Use Pulse Train Output in Sourcing Mode

- Use in sinking mode

The external power supply changes the voltage level of the pulse train output signal. Keep the voltage from an external source between 10.8 Vdc to 16.5 Vdc. Adjust the load impedance to keep the current at 16 mA or lower.

External Power Supply (V)	Load Impedance (kΩ)	Sinking current (mA)
10.8 Vdc to 16.5 Vdc	1.0 kΩ or more	16 mA maximum

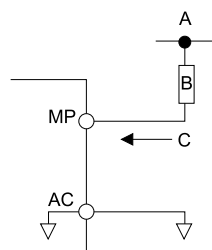

A - External power supply

B - Load Impedance

C - Sinking current

Figure 10.13 Wiring to Use Pulse Train Output in Sinking Mode

## ■ Set Sinking Mode/Sourcing Mode

Close the circuit between terminals SC-SP and SC-SN to set the sinking mode/sourcing mode and the internal/external power supply for the MFDI terminals. The default setting for the drive is internal power supply sinking mode.

**NOTICE** *Damage to Equipment. Do not close the circuit between terminals SP-SN. If you close the circuits between terminals SC-SP and terminals SC-SN at the same time, it will cause damage to the drive.*

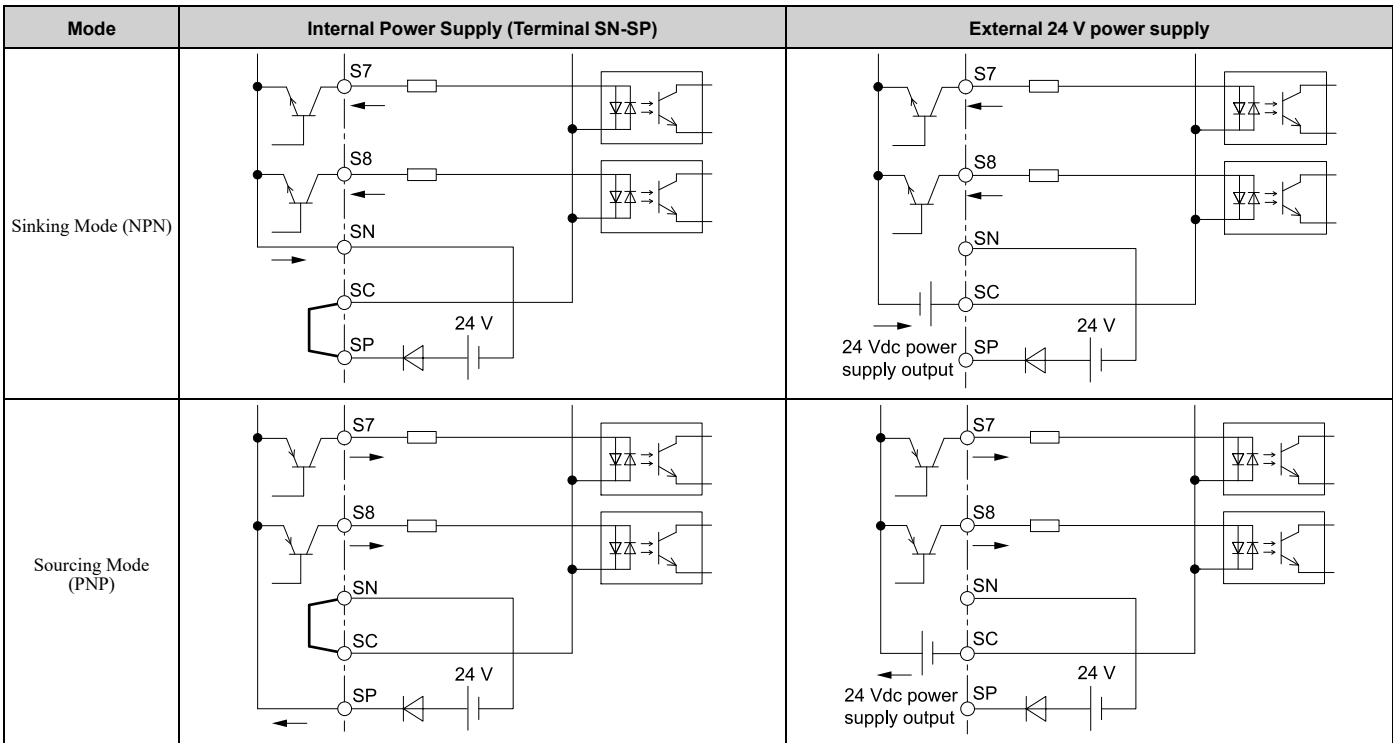

■ Set Input Signals for MFAI Terminals A1 to A3

Use terminals A1 to A3 to input a voltage or a current signal. Set the signal type as shown in [Table 10.9](#).

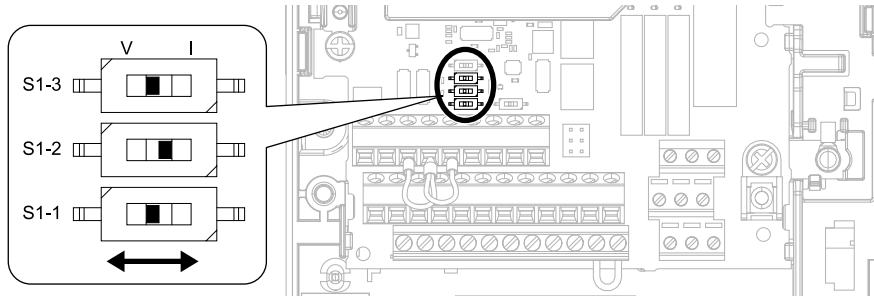

Figure 10.14 Location of DIP Switch S1

Table 10.9 MFAI Terminals A1 to A3 Signal Settings

Terminal	Input Signal	DIP Switch Settings		Parameter	
		Switch	Setting	No.	Signal Level
A1	Voltage input	S1-1	V (Default)	H3-01	0: 0 V to 10 V/0% to 100% (input impedance: 20 kΩ) 1: -10 V to +10 V/-100% to 100% (input impedance: 20 kΩ)
	Current input		I		2: 4 mA to 20 mA/0% to 100% (input impedance: 250 Ω) 3: 0 mA to 20 mA/0% to 100% (input impedance: 250 Ω)
A2	Voltage input	S1-2	V	H3-09	0: 0 V to 10 V/0% to 100% (input impedance: 20 kΩ) 1: -10 V to +10 V/-100% to 100% (input impedance: 20 kΩ)
	Current input		I (Default)		2: 4 mA to 20 mA/0% to 100% (input impedance: 250 Ω) 3: 0 mA to 20 mA/0% to 100% (input impedance: 250 Ω)
A3	Voltage input	S1-3	V (Default)	H3-05	0: 0 V to 10 V/0% to 100% (input impedance: 20 kΩ) 1: -10 V to +10 V/-100% to 100% (input impedance: 20 kΩ)
	Current input		I		2: 4 mA to 20 mA/0% to 100% (input impedance: 250 Ω) 3: 0 mA to 20 mA/0% to 100% (input impedance: 250 Ω)



**Note:**

- Set  $H3-02, H3-10 = 0$  [Terminal A1 Function Selection, Terminal A2 Function Selection = Frequency Reference] to set A1 and A2 to frequency reference. The drive will add the analog input values together to make the frequency reference.
- Use tweezers or a jig with a tip width of approximately 0.8 mm (0.03 in) to set DIP switches.
- Set DIP switch S4 to “AI” to use terminal A3 as an analog input (voltage/current) terminal. The default setting for DIP switch S4 is “AI”.

### ■ Set MFAI Terminal A3 to PTC Input

Set terminal A3 as an MFAI or as the PTC input for motor overload protection.

Use DIP switch S4 to set the input function.

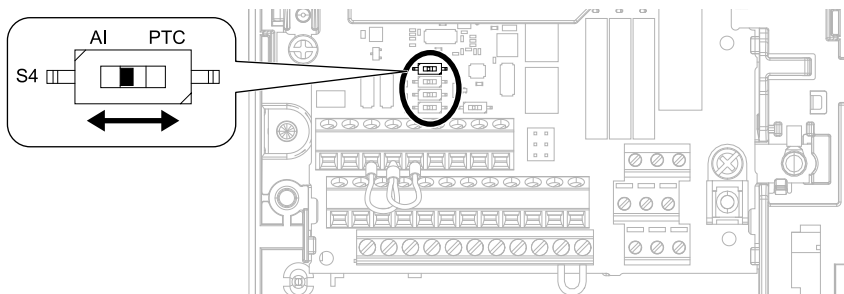

Figure 10.15 Location of DIP Switch S4

Terminal	DIP switch S4	Description
A3	AI (Default)	Functions as an MFAI terminal. Set $H3-06$ [Terminal A3 Function Selection] to set the input function.
	PTC	Functions as the PTC input terminal. Set $H3-06 = E$ [Motor Temperature (PTC Input)]. Set S1-3 to “V” for voltage input.

### ■ Set Output Signals for MFAO Terminals FM, AM

Set the signal type for terminals AM and FM to voltage or current output. Use jumper switch S5 and  $H4-07, H4-08$  [Terminal FM Signal Level Select, Terminal AM Signal Level Select] to set the signal type.

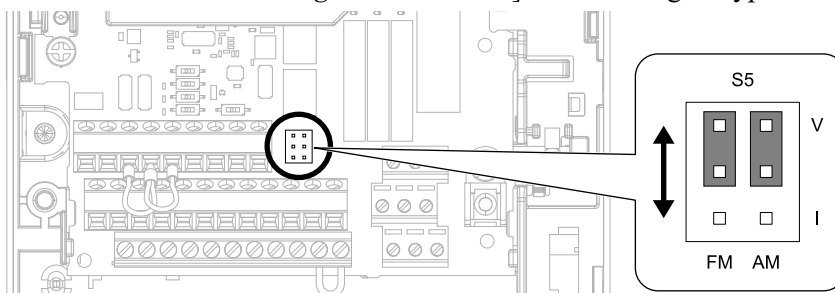





Figure 10.16 Location of Jumper Switch S5

Terminal	Types of Output Signals	Jumper Switch S5	Parameter	
			No.	Signal Level
FM	Voltage output (Default)		H4-07	0: 0 V to 10 V 1: -10 V to +10 V
	Current output			2: 4 mA to 20 mA
AM	Voltage output (Default)		H4-08	0: 0 V to 10 V 1: -10 V to +10 V
	Current output			2: 4 mA to 20 mA

## ■ Switch ON Termination Resistor for MEMOBUS/Modbus Communications

When the drive is the last slave in a MEMOBUS/Modbus communications, set DIP switch S2 to the ON position. This drive has a built-in termination resistor for the RS-485 interface.

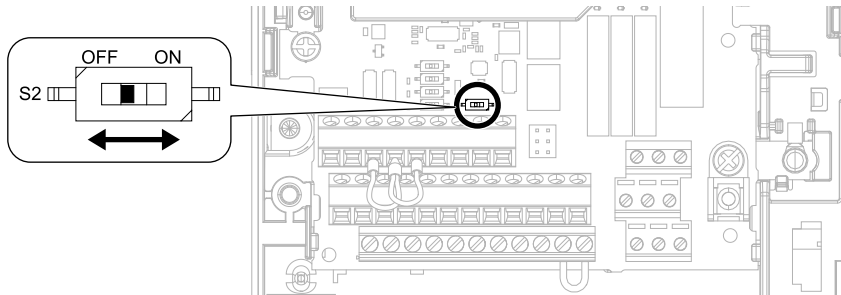

Figure 10.17 Location of DIP Switch S2

Table 10.10 MEMOBUS/Modbus Communications Termination Resistor Setting

DIP Switch S2	Description
ON	The built-in termination resistor is ON.
OFF (Default)	The built-in termination resistor is OFF.

# 11 Drive Control, Duty Modes, and Programming

## ◆ Control Method Selection

This section gives information about these basic control methods:

- V/f Control (V/f)
- Open Loop Vector
- EZ Open Loop Vector Control (EZOLV) for induction motors only

Refer to the Technical Reference for information about speed feedback and Permanent Magnet/Synchronous Reluctance motor control methods.

Set the most applicable control method for your application. Parameter A1-02 [Control Method Selection] sets drive control.

Control Methods	A1-02	Main Applications
V/f	0	<ul style="list-style-type: none"> <li>Use for main variable-speed applications, especially when you operate more than one motor with one drive.</li> <li>Use also when you do not have sufficient data to set the motor parameters.</li> </ul>
OLV	2 (Default)	<ul style="list-style-type: none"> <li>Main Applications of Variable Speed Control</li> <li>Use for applications in which high-precision and high performance are necessary and you do not use speed feedback.</li> </ul>
EZOLV	8	<ul style="list-style-type: none"> <li>Main Applications of Variable Speed Control</li> <li>Use for applications in which high-precision and high performance are not necessary and you do not use speed feedback.</li> </ul>

## ◆ Drive Duty Modes

The drive has two duty modes from which to select for the application: Heavy Duty (HD) and Normal Duty (ND).

- The input power kVA
- The maximum applicable motor output
- The rated input current
- The rated output capacity
- The rated output current

**Note:**

The reference for the parameter set as a percentage of the drive rated output current is the rated output current of HD/ND.

Refer to [Table 11.1](#) for information about the differences between HD and ND ratings.

**Table 11.1 Drive Duty Modes**

Duty Rating	C6-01 Setting	Application	Default Carrier Frequency	Overload Tolerance (oL2 [Drive Overload])
Heavy Duty Rating (HD)	0	<ul style="list-style-type: none"> <li>Extruder</li> <li>Conveyor</li> <li>Constant torque or high overload capacity</li> </ul>	2 kHz	150% of the rated output current for 60 seconds The permitted frequency of overload is one time each 10 minutes.
Normal Duty Rating (ND)	1	<ul style="list-style-type: none"> <li>Fan</li> <li>Pump</li> <li>Blower</li> <li>Variable speed control</li> </ul>	2 kHz Swing-PWM	110% of the rated output current for 60 seconds The permitted frequency of overload is one time each 10 minutes.

## ◆ Auto-Tuning

**⚠ WARNING** *Injury to Personnel. Rotational Auto-Tuning rotates the motor at 50% or more of the motor rated frequency. Make sure that there are no issues related to safety in the area around the drive and motor. Increased motor frequency can cause serious injury or death.*

**⚠ WARNING** *Sudden Movement Hazard. Before you do Rotational Auto-Tuning, disconnect the load from the motor. The load can move suddenly and cause serious injury or death.*

Auto-Tuning automatically sets parameters on the drive connected to the motor. You must input some parameters individually during Auto-Tuning.

1. Select [Auto-Tuning] from the main menu to select the Auto-Tuning Mode.
2. Use the information in [Table 11.2](#) and [Table 11.3](#) to set *T1-01 [Auto-Tuning Mode Selection]* and *T4-01 [EZ Tuning Mode Selection]*.
3. Push  to start Auto-Tuning.  
Refer to the Technical Manual for more information about Auto-Tuning.









**Table 11.2 Auto-Tuning Mode Selection**

Type	T1-01	Application Conditions and Benefits	A1-02 [Control Method Selection]	
			0 [V/f]	2 [OLV]
Rotational Auto-Tuning	0	Recommended tuning mode for the most accurate results. Select this tuning mode when: <ul style="list-style-type: none"> <li>You can decouple the motor from the load.</li> <li>You cannot decouple the motor from the load, but the motor load is less than 30%.</li> </ul>	-	Yes
Stationary Auto-Tuning 1	1	Automatically calculates motor parameters for vector control. Select this tuning mode when: <ul style="list-style-type: none"> <li>You cannot decouple the motor from the load.</li> <li>The motor test report data is not available.</li> </ul>	-	Yes
Line-to-Line Resistance	2	Select this tuning mode when: <ul style="list-style-type: none"> <li>The drive and motor capacities are different.</li> <li>The drive is in V/f Control.</li> <li>You have replaced the drive and motor.</li> </ul>	Yes	Yes

**Table 11.3 EZ Tuning Mode Selection**

Type	T4-01	Application Conditions and Benefits	A1-02 = 8 [EZOLV]
Motor Parameter Setting	0	Set the motor parameters.	Yes
Line-to-Line Resistance	1	Select this tuning mode after you replace the drive, motor, and motor cables.	Yes

## ◆ Drive Parameters

Icon	Description
	The parameter is available when operating the drive with V/f Control.
	The parameter is available when operating the drive with Closed Loop V/f Control.
	The parameter is available when operating the drive with Open Loop Vector Control.
	The parameter is available when operating the drive with Closed Loop Vector Control.
	The parameter is available when operating the drive with Advanced Open Loop Vector Control.
	The parameter is available when operating the drive with Open Loop Vector Control for PM.
	The parameter is available when operating the drive with Advanced Open Loop Vector Control for PM.
	The parameter is available when operating the drive with Closed Loop Vector Control for PM.
	The parameter is available when operating the drive with EZ Open Loop Vector Control.
RUN	You can change the parameter setting during drive operation.

**Note:**

Gray icons identify parameters that are not available in the specified control method.

This section shows the most common parameters for applications. Refer to this table when you set parameters.

No. (Hex.)	Name	Description
A1-00 (0100) RUN	Language Selection	<p><b>V/f</b> <b>CL-V/f</b> <b>OLV</b> <b>CLV</b> <b>AOLV</b> <b>OLV/IPM</b> <b>AOLV/IPM</b> <b>CLV/IPM</b> <b>EZOLV</b></p> <p>Sets the language for the LCD keypad.</p> <p>0 : English 1 : Japanese 2 : German 3 : French 4 : Italian 5 : Spanish 6 : Portuguese 7 : Chinese 8 : Czech 9 : Russian 10 : Turkish 11 : Polish 12 : Greek</p>
A1-02 (0102)	Control Method Selection	<p><b>V/f</b> <b>CL-V/f</b> <b>OLV</b> <b>CLV</b> <b>AOLV</b> <b>OLV/IPM</b> <b>AOLV/IPM</b> <b>CLV/IPM</b> <b>EZOLV</b></p> <p>Sets the control method for the drive application and the motor.</p> <p>0 : V/f Control 1 : V/f Control with Encoder 2 : Open Loop Vector 3 : Closed Loop Vector 4 : Advanced Open Loop Vector 5 : PM Open Loop Vector 6 : PM Advanced Open Loop Vector 7 : PM Closed Loop Vector 8 : EZ Vector Control</p>
A1-03 (0103)	Initialize Parameters	<p><b>V/f</b> <b>CL-V/f</b> <b>OLV</b> <b>CLV</b> <b>AOLV</b> <b>OLV/IPM</b> <b>AOLV/IPM</b> <b>CLV/IPM</b> <b>EZOLV</b></p> <p>Sets parameters to default values.</p> <p>0 : No Initialization 1110 : User Initialization 2220 : 2-Wire Initialization 3330 : 3-Wire Initialization</p>
b1-01 (0180)	Frequency Reference Selection 1	<p><b>V/f</b> <b>CL-V/f</b> <b>OLV</b> <b>CLV</b> <b>AOLV</b> <b>OLV/IPM</b> <b>AOLV/IPM</b> <b>CLV/IPM</b> <b>EZOLV</b></p> <p>Sets the input method for the frequency reference.</p> <p>0 : Keypad 1 : Analog Input 2 : Memobus/Modbus Communications 3 : Option PCB 4 : Pulse Train Input</p>
b1-02 (0181)	Run Command Selection 1	<p><b>V/f</b> <b>CL-V/f</b> <b>OLV</b> <b>CLV</b> <b>AOLV</b> <b>OLV/IPM</b> <b>AOLV/IPM</b> <b>CLV/IPM</b> <b>EZOLV</b></p> <p>Sets the input method for the Run command.</p> <p>0 : Keypad 1 : Digital Input 2 : Memobus/Modbus Communications 3 : Option PCB</p>
b1-03 (0182)	Stopping Method Selection	<p><b>V/f</b> <b>CL-V/f</b> <b>OLV</b> <b>CLV</b> <b>AOLV</b> <b>OLV/IPM</b> <b>AOLV/IPM</b> <b>CLV/IPM</b> <b>EZOLV</b></p> <p>Sets the method to stop the motor after removing a Run command or entering a Stop command.</p> <p>0 : Ramp to Stop 1 : Coast to Stop 2 : DC Injection Braking to Stop 3 : Coast to Stop with Timer</p>
b1-04 (0183)	Reverse Operation Selection	<p><b>V/f</b> <b>CL-V/f</b> <b>OLV</b> <b>CLV</b> <b>AOLV</b> <b>OLV/IPM</b> <b>AOLV/IPM</b> <b>CLV/IPM</b> <b>EZOLV</b></p> <p>Sets the reverse operation function. Disable reverse operation in fan or pump applications where reverse rotation is dangerous.</p> <p>0 : Reverse Enabled 1 : Reverse Disabled</p>
C1-01 (0200) RUN	Acceleration Time 1	<p><b>V/f</b> <b>CL-V/f</b> <b>OLV</b> <b>CLV</b> <b>AOLV</b> <b>OLV/IPM</b> <b>AOLV/IPM</b> <b>CLV/IPM</b> <b>EZOLV</b></p> <p>Sets the length of time to accelerate from zero to maximum output frequency.</p>
C1-02 (0201) RUN	Deceleration Time 1	<p><b>V/f</b> <b>CL-V/f</b> <b>OLV</b> <b>CLV</b> <b>AOLV</b> <b>OLV/IPM</b> <b>AOLV/IPM</b> <b>CLV/IPM</b> <b>EZOLV</b></p> <p>Sets the length of time to decelerate from maximum output frequency to zero.</p>

# 11 Drive Control, Duty Modes, and Programming

No. (Hex.)	Name	Description
C2-01 (020B)	S-Curve Time @ Start of Accel	<b>V/f</b> <b>CL-V/f</b> <b>OLV</b> <b>CLV</b> <b>AOLV</b> <b>OLV/PM</b> <b>AOLV/PM</b> <b>CLV/PM</b> <b>EZOLV</b> Sets the S-curve acceleration time at start.
C2-02 (020C)	S-Curve Time @ End of Accel	<b>V/f</b> <b>CL-V/f</b> <b>OLV</b> <b>CLV</b> <b>AOLV</b> <b>OLV/PM</b> <b>AOLV/PM</b> <b>CLV/PM</b> <b>EZOLV</b> Sets the S-curve acceleration time at completion.
C2-03 (020D)	S-Curve Time @ Start of Decel	<b>V/f</b> <b>CL-V/f</b> <b>OLV</b> <b>CLV</b> <b>AOLV</b> <b>OLV/PM</b> <b>AOLV/PM</b> <b>CLV/PM</b> <b>EZOLV</b> Sets the S-curve deceleration time at start.
C2-04 (020E)	S-Curve Time @ End of Decel	<b>V/f</b> <b>CL-V/f</b> <b>OLV</b> <b>CLV</b> <b>AOLV</b> <b>OLV/PM</b> <b>AOLV/PM</b> <b>CLV/PM</b> <b>EZOLV</b> Sets the S-curve deceleration time at completion.
C6-01 (0223)	Normal / Heavy Duty Selection	<b>V/f</b> <b>CL-V/f</b> <b>OLV</b> <b>CLV</b> <b>AOLV</b> <b>OLV/PM</b> <b>AOLV/PM</b> <b>CLV/PM</b> <b>EZOLV</b> Sets the drive duty rating. 0 : Heavy Duty Rating 1 : Normal Duty Rating
C6-02 (0224)	Carrier Frequency Selection	<b>V/f</b> <b>CL-V/f</b> <b>OLV</b> <b>CLV</b> <b>AOLV</b> <b>OLV/PM</b> <b>AOLV/PM</b> <b>CLV/PM</b> <b>EZOLV</b> Sets the carrier frequency for the transistors in the drive. 1 : 2.0 kHz 2 : 5.0 kHz (4.0 kHz for AOLV/PM) 3 : 8.0 kHz (6.0 kHz for AOLV/PM) 4 : 10.0 kHz (8.0 kHz for AOLV/PM) 5 : 12.5 kHz (10.0 kHz for AOLV/PM) 6 : 15.0 kHz (12.0 kHz for AOLV/PM) 7 : Swing PWM4 (Audible Sound 1) 8 : Swing PWM4 (Audible Sound 2) 9 : Swing PWM4 (Audible Sound 3) A : Swing PWM4 (Audible Sound 4) F : User Defined (C6-03 to C6-05)
d1-01 - d1-16 (0280 - 0291) RUN	Reference 1 to 16	<b>V/f</b> <b>CL-V/f</b> <b>OLV</b> <b>CLV</b> <b>AOLV</b> <b>OLV/PM</b> <b>AOLV/PM</b> <b>CLV/PM</b> <b>EZOLV</b> Sets the frequency reference in the units from 01-03 [Frequency Display Unit Selection].
d1-17 (0292) RUN	Jog Reference	<b>V/f</b> <b>CL-V/f</b> <b>OLV</b> <b>CLV</b> <b>AOLV</b> <b>OLV/PM</b> <b>AOLV/PM</b> <b>CLV/PM</b> <b>EZOLV</b> Sets the Jog frequency reference in the units from 01-03 [Frequency Display Unit Selection]. Set H1-xx = 6 [MFDI Function Select = Jog Reference Selection] to use the Jog frequency reference.
d2-01 (0289)	Frequency Reference Upper Limit	<b>V/f</b> <b>CL-V/f</b> <b>OLV</b> <b>CLV</b> <b>AOLV</b> <b>OLV/PM</b> <b>AOLV/PM</b> <b>CLV/PM</b> <b>EZOLV</b> Sets maximum limit for all frequency references. The maximum output frequency is 100%.
d2-02 (028A)	Frequency Reference Lower Limit	<b>V/f</b> <b>CL-V/f</b> <b>OLV</b> <b>CLV</b> <b>AOLV</b> <b>OLV/PM</b> <b>AOLV/PM</b> <b>CLV/PM</b> <b>EZOLV</b> Sets minimum limit for all frequency references. The maximum output frequency is 100%.
E1-01 (0300)	Input AC Supply Voltage	<b>V/f</b> <b>CL-V/f</b> <b>OLV</b> <b>CLV</b> <b>AOLV</b> <b>OLV/PM</b> <b>AOLV/PM</b> <b>CLV/PM</b> <b>EZOLV</b> Sets the drive input voltage.
E1-04 (0303)	Maximum Output Frequency	<b>V/f</b> <b>CL-V/f</b> <b>OLV</b> <b>CLV</b> <b>AOLV</b> <b>OLV/PM</b> <b>AOLV/PM</b> <b>CLV/PM</b> <b>EZOLV</b> Sets the maximum output frequency for the V/f pattern.
E1-05 (0304)	Maximum Output Voltage	<b>V/f</b> <b>CL-V/f</b> <b>OLV</b> <b>CLV</b> <b>AOLV</b> <b>OLV/PM</b> <b>AOLV/PM</b> <b>CLV/PM</b> <b>EZOLV</b> Sets the maximum output voltage for the V/f pattern.
E1-06 (0305)	Base Frequency	<b>V/f</b> <b>CL-V/f</b> <b>OLV</b> <b>CLV</b> <b>AOLV</b> <b>OLV/PM</b> <b>AOLV/PM</b> <b>CLV/PM</b> <b>EZOLV</b> Sets the base frequency for the V/f pattern.
E1-09 (0308)	Minimum Output Frequency	<b>V/f</b> <b>CL-V/f</b> <b>OLV</b> <b>CLV</b> <b>AOLV</b> <b>OLV/PM</b> <b>AOLV/PM</b> <b>CLV/PM</b> <b>EZOLV</b> Sets the minimum output frequency for the V/f pattern.
E2-01 (030E)	Motor Rated Current (FLA)	<b>V/f</b> <b>CL-V/f</b> <b>OLV</b> <b>CLV</b> <b>AOLV</b> <b>OLV/PM</b> <b>AOLV/PM</b> <b>CLV/PM</b> <b>EZOLV</b> Sets the motor rated current in amps.
E2-11 (0318)	Motor Rated Power	<b>V/f</b> <b>CL-V/f</b> <b>OLV</b> <b>CLV</b> <b>AOLV</b> <b>OLV/PM</b> <b>AOLV/PM</b> <b>CLV/PM</b> <b>EZOLV</b> Sets the motor rated output in the units from 01-58 [Motor Power Unit Selection].
H1-01 - H1-08 (0438, 0439, 0400 - 0405)	Term S1 to S8 Function Selection	<b>V/f</b> <b>CL-V/f</b> <b>OLV</b> <b>CLV</b> <b>AOLV</b> <b>OLV/PM</b> <b>AOLV/PM</b> <b>CLV/PM</b> <b>EZOLV</b> Sets the functions for MFDI terminals S1 to S8.
H2-01 (040B)	Term M1-M2 Function Selection	<b>V/f</b> <b>CL-V/f</b> <b>OLV</b> <b>CLV</b> <b>AOLV</b> <b>OLV/PM</b> <b>AOLV/PM</b> <b>CLV/PM</b> <b>EZOLV</b> Sets the function for MFDO terminal M1-M2.
H2-02 (040C)	Term M3-M4 Function Selection	<b>V/f</b> <b>CL-V/f</b> <b>OLV</b> <b>CLV</b> <b>AOLV</b> <b>OLV/PM</b> <b>AOLV/PM</b> <b>CLV/PM</b> <b>EZOLV</b> Sets the function for MFDO terminal M3-M4.

No. (Hex.)	Name	Description
H2-03 (040D)	Term M5-M6 Function Selection	<b>V/f</b> <b>CL-V/f</b> <b>OLV</b> <b>CLV</b> <b>AOLV</b> <b>OLV/PM</b> <b>AOLV/PM</b> <b>CLV/PM</b> <b>EZOLV</b> Sets the function for MFDO terminal M5-M6.
H3-01 (0410)	Terminal A1 Signal Level Select	<b>V/f</b> <b>CL-V/f</b> <b>OLV</b> <b>CLV</b> <b>AOLV</b> <b>OLV/PM</b> <b>AOLV/PM</b> <b>CLV/PM</b> <b>EZOLV</b> Sets the input signal level for MFAI terminal A1. 0 : 0-10V (Lower Limit at 0) 1 : -10 to +10V (Bipolar Reference) 2 : 4 to 20 mA 3 : 0 to 20 mA
H3-02 (0434)	Terminal A1 Function Selection	<b>V/f</b> <b>CL-V/f</b> <b>OLV</b> <b>CLV</b> <b>AOLV</b> <b>OLV/PM</b> <b>AOLV/PM</b> <b>CLV/PM</b> <b>EZOLV</b> Sets the function for MFAI terminal A1.
H3-03 (0411) RUN	Terminal A1 Gain Setting	<b>V/f</b> <b>CL-V/f</b> <b>OLV</b> <b>CLV</b> <b>AOLV</b> <b>OLV/PM</b> <b>AOLV/PM</b> <b>CLV/PM</b> <b>EZOLV</b> Sets the gain of the analog signal input to MFAI terminal A1.
H3-04 (0412) RUN	Terminal A1 Bias Setting	<b>V/f</b> <b>CL-V/f</b> <b>OLV</b> <b>CLV</b> <b>AOLV</b> <b>OLV/PM</b> <b>AOLV/PM</b> <b>CLV/PM</b> <b>EZOLV</b> Sets the bias of the analog signal input to MFAI terminal A1.
H3-05 (0413)	Terminal A3 Signal Level Select	<b>V/f</b> <b>CL-V/f</b> <b>OLV</b> <b>CLV</b> <b>AOLV</b> <b>OLV/PM</b> <b>AOLV/PM</b> <b>CLV/PM</b> <b>EZOLV</b> Sets the input signal level for MFAI terminal A3. 0 : 0-10V (Lower Limit at 0) 1 : -10 to +10V (Bipolar Reference) 2 : 4 to 20 mA 3 : 0 to 20 mA
H3-06 (0414)	Terminal A3 Function Selection	<b>V/f</b> <b>CL-V/f</b> <b>OLV</b> <b>CLV</b> <b>AOLV</b> <b>OLV/PM</b> <b>AOLV/PM</b> <b>CLV/PM</b> <b>EZOLV</b> Sets the function for MFAI terminal A3.
H3-07 (0415) RUN	Terminal A3 Gain Setting	<b>V/f</b> <b>CL-V/f</b> <b>OLV</b> <b>CLV</b> <b>AOLV</b> <b>OLV/PM</b> <b>AOLV/PM</b> <b>CLV/PM</b> <b>EZOLV</b> Sets the gain of the analog signal input to MFAI terminal A3.
H3-08 (0416) RUN	Terminal A3 Bias Setting	<b>V/f</b> <b>CL-V/f</b> <b>OLV</b> <b>CLV</b> <b>AOLV</b> <b>OLV/PM</b> <b>AOLV/PM</b> <b>CLV/PM</b> <b>EZOLV</b> Sets the bias of the analog signal input to MFAI terminal A3.
H3-09 (0417)	Terminal A2 Signal Level Select	<b>V/f</b> <b>CL-V/f</b> <b>OLV</b> <b>CLV</b> <b>AOLV</b> <b>OLV/PM</b> <b>AOLV/PM</b> <b>CLV/PM</b> <b>EZOLV</b> Sets the input signal level for MFAI terminal A2. 0 : 0-10V (Lower Limit at 0) 1 : -10 to +10V (Bipolar Reference) 2 : 4 to 20 mA 3 : 0 to 20 mA
H3-10 (0418)	Terminal A2 Function Selection	<b>V/f</b> <b>CL-V/f</b> <b>OLV</b> <b>CLV</b> <b>AOLV</b> <b>OLV/PM</b> <b>AOLV/PM</b> <b>CLV/PM</b> <b>EZOLV</b> Sets the function for MFAI terminal A2.
H3-11 (0419) RUN	Terminal A2 Gain Setting	<b>V/f</b> <b>CL-V/f</b> <b>OLV</b> <b>CLV</b> <b>AOLV</b> <b>OLV/PM</b> <b>AOLV/PM</b> <b>CLV/PM</b> <b>EZOLV</b> Sets the gain of the analog signal input to MFAI terminal A2.
H3-12 (041A) RUN	Terminal A2 Bias Setting	<b>V/f</b> <b>CL-V/f</b> <b>OLV</b> <b>CLV</b> <b>AOLV</b> <b>OLV/PM</b> <b>AOLV/PM</b> <b>CLV/PM</b> <b>EZOLV</b> Sets the bias of the analog signal input to MFAI terminal A2.
H3-13 (041B)	Analog Input FilterTime Constant	<b>V/f</b> <b>CL-V/f</b> <b>OLV</b> <b>CLV</b> <b>AOLV</b> <b>OLV/PM</b> <b>AOLV/PM</b> <b>CLV/PM</b> <b>EZOLV</b> Sets the time constant for primary delay filters on MFAI terminals.
H3-14 (041C)	Analog Input Terminal Enable Sel	<b>V/f</b> <b>CL-V/f</b> <b>OLV</b> <b>CLV</b> <b>AOLV</b> <b>OLV/PM</b> <b>AOLV/PM</b> <b>CLV/PM</b> <b>EZOLV</b> Sets the enabled terminal or terminals when $H1-xx = C$ [MFDI Function Select = Analog Terminal Enable Selection] is ON. 1 : Terminal A1 only 2 : Terminal A2 only 3 : Terminals A1 and A2 4 : Terminal A3 only 5 : Terminals A1 and A3 6 : Terminals A2 and A3 7 : Terminals A1, A2, and A3
H4-01 (041D)	Terminal FM Analog Output Select	<b>V/f</b> <b>CL-V/f</b> <b>OLV</b> <b>CLV</b> <b>AOLV</b> <b>OLV/PM</b> <b>AOLV/PM</b> <b>CLV/PM</b> <b>EZOLV</b> Sets the monitor number to send from MFAO terminal FM.

No. (Hex.)	Name	Description
H4-02 (041E) RUN	Terminal FM Analog Output Gain	<b>V/f</b> <b>CL-V/f</b> <b>OLV</b> <b>CLV</b> <b>AOLV</b> <b>OLV/PM</b> <b>AOLV/PM</b> <b>CLV/PM</b> <b>EZOLV</b> Sets the gain of the monitor signal that is sent from MFAO terminal FM.
H4-03 (041F) RUN	Terminal FM Analog Output Bias	<b>V/f</b> <b>CL-V/f</b> <b>OLV</b> <b>CLV</b> <b>AOLV</b> <b>OLV/PM</b> <b>AOLV/PM</b> <b>CLV/PM</b> <b>EZOLV</b> Sets the bias of the monitor signal that is sent from MFAO terminal FM.
H4-04 (0420)	Terminal AM Analog Output Select	<b>V/f</b> <b>CL-V/f</b> <b>OLV</b> <b>CLV</b> <b>AOLV</b> <b>OLV/PM</b> <b>AOLV/PM</b> <b>CLV/PM</b> <b>EZOLV</b> Sets the monitoring number to be output from the MFAO terminal AM.
H4-05 (0421) RUN	Terminal AM Analog Output Gain	<b>V/f</b> <b>CL-V/f</b> <b>OLV</b> <b>CLV</b> <b>AOLV</b> <b>OLV/PM</b> <b>AOLV/PM</b> <b>CLV/PM</b> <b>EZOLV</b> Sets the gain of the monitor signal that is sent from MFAO terminal AM.
H4-06 (0422) RUN	Terminal AM Analog Output Bias	<b>V/f</b> <b>CL-V/f</b> <b>OLV</b> <b>CLV</b> <b>AOLV</b> <b>OLV/PM</b> <b>AOLV/PM</b> <b>CLV/PM</b> <b>EZOLV</b> Sets the bias of the monitor signal that is sent from MFAO terminal AM.
H4-07 (0423)	Terminal FM Signal Level Select	<b>V/f</b> <b>CL-V/f</b> <b>OLV</b> <b>CLV</b> <b>AOLV</b> <b>OLV/PM</b> <b>AOLV/PM</b> <b>CLV/PM</b> <b>EZOLV</b> Sets the MFAO terminal FM output signal level. 0 : 0-10V (Lower Limit at 0) 1 : -10 to +10V (Bipolar Reference) 2 : 4 to 20 mA
H4-08 (0424)	Terminal AM Signal Level Select	<b>V/f</b> <b>CL-V/f</b> <b>OLV</b> <b>CLV</b> <b>AOLV</b> <b>OLV/PM</b> <b>AOLV/PM</b> <b>CLV/PM</b> <b>EZOLV</b> Sets the MFAO terminal AM output signal level. 0 : 0 to 10 Vdc 1 : -10 to +10 Vdc 2 : 4 to 20 mA
L1-01 (0480)	Motor Overload (oL1) Protection	<b>V/f</b> <b>CL-V/f</b> <b>OLV</b> <b>CLV</b> <b>AOLV</b> <b>OLV/PM</b> <b>AOLV/PM</b> <b>CLV/PM</b> <b>EZOLV</b> Sets the motor overload protection with electronic thermal protectors. 0 : Disable 1 : Variable Torque 2 : Constant Torque 10:1 Speed Range 3 : Constant Torque 100:1 SpeedRange 4 : PM Variable Torque 5 : PM Constant Torque 6 : Variable Torque (50Hz)
L1-02 (0481)	Motor Overload Protection Time	<b>V/f</b> <b>CL-V/f</b> <b>OLV</b> <b>CLV</b> <b>AOLV</b> <b>OLV/PM</b> <b>AOLV/PM</b> <b>CLV/PM</b> <b>EZOLV</b> Sets the operation time for the electronic thermal protector of the drive to prevent damage to the motor. Usually it is not necessary to change this setting.
L3-04 (0492)	Stall Prevention during Decel	<b>V/f</b> <b>CL-V/f</b> <b>OLV</b> <b>CLV</b> <b>AOLV</b> <b>OLV/PM</b> <b>AOLV/PM</b> <b>CLV/PM</b> <b>EZOLV</b> Sets the method that the drive will use to prevent overvoltage faults when decelerating. 0 : Disable 1 : General Purpose 2 : Intelligent (Ignore Accel Ramp) 3 : General Purpose w/ DB resistor 4 : Overexcitation/High Flux 1 5 : Overexcitation/High Flux 2
o1-58 (3125)	Motor Power Unit Selection	<b>V/f</b> <b>CL-V/f</b> <b>OLV</b> <b>CLV</b> <b>AOLV</b> <b>OLV/PM</b> <b>AOLV/PM</b> <b>CLV/PM</b> <b>EZOLV</b> Sets the setting unit for parameters that set the motor rated power. 0 : kW 1 : HP

**12 UL Standards**



Figure 12.1 UL/cUL Mark



The UL/cUL Mark identifies that this product conforms to rigid safety standards. This mark appears on products in the United States and Canada. It shows UL approval, which identifies that the product complies with safety standards after careful inspection and assessment. You must use UL Listed or UL Recognized parts for all primary components that are built into electrical equipment that has UL approval.

This product has been tested in accordance with UL standard UL 508C, and has been verified to be in compliance with UL standards.

Machines and devices integrated with this product must satisfy the following conditions for compliance with UL standards:

## ◆ Area of Use

Install this product in a location with Overvoltage Category III and pollution degree 2 or less as specified in UL 508C.

### ■ Surrounding Air Temperature

Keep the ambient temperature in these ranges according to the enclosure type.

- IP20/UL Type 1: -10 °C to +40 °C (14 °F to 104 °F)
- IP20/UL Open Type/Heatsink External Mounting: -10 °C to +50 °C (14 °F to 122 °F)
- IP55/UL Type 12 Heatsink External Mounting; front side: -10°C to +50 °C (14 °F to 122 °F)
- IP55/UL Type 12 Heatsink External Mounting; back side: -10°C to +40 °C (14 °F to 104 °F)

## ◆ Main Circuit Wire Gauges and Tightening Torques

Refer to *Three-Phase 200 V Class on page 31* and *Three-Phase 400 V Class on page 35* for the recommended wire gauges and tightening torques of the main circuit terminals.

Comply with local standards for correct wire gauges in the region where the drive is used.

**▲ WARNING** *Electrical Shock Hazard. Only connect peripheral options, for example a DC link choke or braking resistor, to terminals +1, +2, +3, -, B1, and B2. Incorrect wiring can cause serious injury or death.*

#### Note:

- The recommended wire gauges are based on drive continuous current ratings with 75 °C (167 °F) 600 V class 2 heat-resistant indoor PVC wire. Assume these conditions:
  - Surrounding air temperature: 40 °C (104 °F) or lower
  - Wiring distance: 100 m (328 ft) or shorter
  - Normal Duty Rated current value
- Refer to the instruction manual for each device for recommended wire gauges to connect peripheral devices or options to terminals +1, +2, +3, -, B1, and B2. Contact Yaskawa or your nearest sales representative if the recommended wire gauges for the peripheral devices or options are out of the range of the applicable gauges for the drive.
- 2257 to 2415 and 4208 to 4720, use UL-approved closed-loop crimp terminals on the drive main circuit terminals. Use the tools recommend by the terminal manufacturer and make sure that the terminals are correctly connected.

## ◆ Closed-Loop Crimp Terminals

To comply with UL standards on drive models 2257 to 2415, and 4208 to 4675, use UL-approved closed-loop crimp terminals and heat-shrinkable tubing. Use the tools recommend by the terminal manufacturer to crimp the closed-loop crimp terminal. Yaskawa recommends closed-loop crimp terminals and heat-shrinkable tubing from PANDUIT Corp.

Make sure that you comply with local standards for correct wire gauges in the region where you will use the drive.

Refer to [Table 12.1](#) and [Table 12.2](#) to select crimp terminals as specified by drive model and wire gauge.

#### Note:

To comply with UL standards, use only insulated crimp terminals or crimp terminals with insulation tubing. Use UL-Listed, vinyl-coated insulated copper wires for operation with a continuous maximum permitted temperature of 75 °C at 600 V.

**Table 12.1 Closed-Loop Crimp Terminals for Three-Phase 200 V Class Drives (Manufacturer: PANDUIT Corp.)**

Model	Recomm. Gauge (AWG, kcmil)					Crimp Terminal Model */
	R/L1 S/L2 T/L3	U/T1 V/T2 W/T3	-, +1	+3	⊕	
2004 - 2021	-	-	-	-	10	P10-8R-L
2030, 2042	-	-	-	-	8	P8-10R-Q S8-10R-Q
2056	-	-	-	-	6	P6-14R-E S6-10R-E
2070 - 2110	-	-	-	-	6	P6-14R-E S6-10R-E
2138	-	-	-	-	4	P4-14R-E S4-56R-E
2169, 2211	-	-	-	-	4	P4-56R-E S4-56R-E
2257	-	-	-	-	3	S2-38R-X
	-	-	-	1/0 × 2P	-	S1/0-38R-X
	2/0 × 2P	2/0 × 2P	-	-	-	S2/0-38R-X
	-	-	4/0 × 2P	-	-	S4/0-38R-5
2313	-	-	-	-	2	S2-38R-X
	-	-	-	1/0 × 2P	-	S1/0-38R-X
	-	3/0 × 2P	-	-	-	S3/0-38R-5
	4/0 × 2P	-	-	-	-	S4/0-38R-5
	-	-	250 × 2P	-	-	S250-38R-5
2360	-	-	-	-	1	S2-12R-X
	-	-	-	3/0 × 2P	-	S3/0-12R-5
	250 × 2P	250 × 2P	-	-	-	S250-12R-5
	-	-	350 × 2P	-	-	LCA350-12-X LCAX350-12-6
2415	-	-	-	-	1	S2-12R-X
	-	-	-	3/0 × 2P	-	S3/0-12R-5
	250 × 2P	-	-	-	-	S250-12R-5
	-	300 × 2P	-	-	-	LCA300-12-X LCAX300-12-6
	-	-	350 × 2P	-	-	LCA350-12-X LCAX350-12-6

\*1 For use with PANDUIT Corp. heat-shrinkable tubing HSTT-series or an equivalent UL-recognized heat-shrinkable tubing rated 600 V minimum.

**Table 12.2 Closed-Loop Crimp Terminals for Three-Phase 400 V Class Drives (Manufacturer: PANDUIT Corp.)**

Model	Recomm. Gauge (AWG, kcmil)					Crimp Terminal Model */
	R/L1 S/L2 T/L3	U/T1 V/T2 W/T3	-, +1	+3	⊕	
4002, 4004	-	-	-	-	12	P10-8R-L
4005 - 4012	-	-	-	-	10	P10-8R-L
4018, 4023	-	-	-	-	10	P10-10R-L
4031	-	-	-	-	8	P8-14R-Q S8-14R-Q

Model	Recomm. Gauge (AWG, kcmil)					Crimp Terminal Model */
	R/L1 S/L2 T/L3	U/T1 V/T2 W/T3	-, +1	+3	⊕	
4038	-	-	-	-	6	P6-14R-E S6-14R-E
4044, 4060	-	-	-	-	6	P6-14R-E S6-14R-E
4075	-	-	-	-	6	P6-14R-E S6-14R-E
4089, 4103	-	-	-	-	4	P4-14R-E S4-14R-E
4140, 4168	-	-	-	-	4	P4-56R-E S4-56R-E
4208	-	-	-	-	4	P4-38R-E S4-38R-E
	1/0 × 2P	1/0 × 2P	-	1/0 × 2P	-	S1/0-38R-X
	-	-	3/0 × 2P	-	-	S3/0-38R-5
4250	-	-	-	-	2	P2-38R-X S2-38R-X
	-	-	-	1/0 × 2P	-	S1/0-38R-X
	2/0 × 2P	2/0 × 2P	-	-	-	S2/0-38R-X
	-	-	3/0 × 2P	-	-	S3/0-38R-5
4302	-	-	-	-	2	P2-38R-X S2-38R-X
	-	-	-	1/0 × 2P	-	S1/0-38R-X
	3/0 × 2P	3/0 × 2P	-	-	-	S3/0-38R-5
	-	-	4/0 × 2P	-	-	S4/0-38R-5
4371	-	-	-	-	1	S2-12R-X
	-	-	-	3/0 × 2P	-	S3/0-12R-5
	250 × 2P	250 × 2P	-	-	-	S250-12R-5
	-	-	350 × 2P	-	-	LCA350-12-X LCAX350-12-6
4414	-	-	-	-	1	S2-12R-X
	-	-	-	4/0 × 2P	-	S4/0-12R-5
	300 × 2P	300 × 2P	-	-	-	LCA300-12-X LCAX300-12-6
	-	-	400 × 2P	-	-	LCA400-12-6
4477	-	-	-	-	1/0	S1/0-12R-X
	-	-	-	3/0 × 4P	-	S3/0-12R-5
	-	4/0 × 4P	4/0 × 4P	-	-	S4/0-12R-5
	250 × 4P	-	-	-	-	S250-12R-5
4568	-	-	-	-	2/0	S2/0-12R-X
	-	-	-	3/0 × 4P	-	S3/0-12R-5
	-	4/0 × 4P	-	-	-	S4/0-12R-5
	250 × 4P	-	-	-	-	S250-12R-5
	-	-	300 × 4P	-	-	LCA300-12-X LCAX300-12-6

Model	Recomm. Gauge (AWG, kcmil)					Crimp Terminal Model */
	R/L1 S/L2 T/L3	U/T1 V/T2 W/T3	-, +1	+3	⊕	
4605	-	-	-	-	2/0	S2/0-12R-X
	-	-	-	4/0 × 4P	-	S4/0-12R-5
	300 × 4P	300 × 4P	-	-	-	LCA300-12-X LCAX300-12-6
	-	-	400 × 4P	-	-	LCA400-12-6
4720	-	-	-	-	2/0	S2/0-12R-X
	-	-	-	4/0 × 4P	-	S4/0-12R-5
	300 × 4P	300 × 4P	-	-	-	LCA300-12-X LCAX300-12-6
	-	-	400 × 4P	-	-	LCA400-12-6

\*1 For use with PANDUIT Corp. heat-shrinkable tubing HSTT-series or an equivalent UL-recognized heat-shrinkable tubing rated 600 V minimum.

### ◆ Factory-Recommended Branch Circuit Protection for UL Listing

Install one of the types of short circuit protection devices to comply with UL 508C. Yaskawa recommends connecting semiconductor protection fuses. Refer to *Three-Phase 200 V Class on page 77* and *Three-Phase 400 V Class on page 78* for recommended fuses and alternative short circuit protection devices.

- Semiconductor Protection Fuse
    - When you use semiconductor fuses as UL listed drive protection, the drives and fuses must be in the same enclosure.
    - Where multiple semiconductor fuse ratings are listed for a single drive, Yaskawa recommends a fuse with a large rated current for applications with repeated loads of approximately 150%. You can use smaller semiconductor fuses (than what is listed) of the same manufacturer and series. Please note that this can decrease the life of the fuses.
  - Non-Semiconductor Fuse
    - Maximum CC, J, T, RK1 or RK5 fuse rating is 175% of the Normal-Duty drive full load output amp (FLA) rating.
    - When you use class CC, J, or T fuses as UL listed drive protection, models 4371 and larger have the same minimum enclosure volume requirements as MCCBs.
    - Install Class RK1 or RK5 fuses into a ventilated enclosure with a minimum enclosure volume shown in [Table 12.3](#) and [Table 12.4](#).
  - Molded-Case Circuit Breaker (MCCB)
    - Maximum MCCB rating is 200% of the Normal-Duty drive full load output amp (FLA) rating.
    - When you use MCCBs, install the drive into a ventilated enclosure with a minimum enclosure volume shown in [Table 12.3](#) and [Table 12.4](#).
- Note:**  
Yaskawa recommends current limiting MCCBs.
- Short Circuit Current Rating (SCCR)
 

The maximum SCCR provided by drive and fuse, or drive and MCCB combinations in this document, is 100,000 RMS symmetrical amps.

    - 240 V Cass drives: Use the protection specified in this document to prepare the drive for use on a circuit that supplies not more than 100,000 RMS and not more than 240 Vac when there is a short circuit in the power supply.
    - 480 V Class drives: Use the protection specified in this document to prepare the drive for use on a circuit that supplies not more than 100,000 RMS and not more than 480 Vac when there is a short circuit in the power supply.

## ■ Three-Phase 200 V Class

**Table 12.3 Required Short Circuit Protection**

Drive Model	Drive Mounted without Supplemental Enclosure (Using UL Type 1 Kit)		Drive Mounted in Supplemental Enclosure					
			Any Size Protected Enclosure (Ventilated/Non-Ventilated)		Restricted Size Protected Enclosure (Ventilated Only)			
	Semiconductor Fuse Manufacturer: EATON/ Bussmann (Permitted Only in UL Type 1 Kit)	Class CC, J, or T Fuse Maximum Amps (A) (Permitted in Same or Separate Enclosure)	Semiconductor Fuse Manufacturer: EATON/ Bussmann (Drive and Fuses in Same Enclosure Only)	Class CC, J, or T Fuse Maximum Amps (A) (Permitted in Same or Separate Enclosure)	These Devices Permitted in Same or Separate Enclosure			
					Class CC, J, or T Fuse Maximum Amps (A)	MCCB Maximum Amps (A)	Class RK1 or RK5 Fuse Maximum Amps (A)	Minimum Enclosure Volume (in <sup>3</sup> )
2004	N/A *1	7	FWH-45B	7	*2	15	7	4195
2006	N/A *1	10	FWH-45B	10	*2	15	10	4195
2008	N/A *1	12	FWH-45B	12	*2	15	12	4195
2010	N/A *1	15	FWH-45B	15	*2	15	15	4195
2012	N/A *1	20	FWH-50B, FWH-80B	20	*2	20	20	4195
2018	N/A *1	30	FWH-80B, FWH-100B	30	*2	35	30	4195
2021	N/A *1	35	FWH-80B, FWH-100B	35	*2	40	35	4195
2030	N/A *1	50	FWH-100B, FWH-125B	50	*2	60	50	4195
2042	N/A *1	70	FWH-150B	70	*2	80	70	4195
2056	N/A *1	90	FWH-200B	90	*2	110	90	4195
2070	N/A *1	110	FWH-200B, FWH-225A	110	*2	125	110	4195
2082	N/A *1	125	FWH-225A, FWH-250A	125	*2	150	125	4195
2110	N/A *1	175	FWH-225A, FWH-250A	175	*2	200	175	10121
2138	N/A *1	225	FWH-275A, FWH-300A	225	*2	250	225	10121
2169	N/A *1	250	FWH-275A, FWH-350A	250	*2	300	250	10121
2211	N/A *1	350	FWH-325A, FWH-450A	350	*2	400	350	10121
2257	N/A *1	400	FWH-600A	400	*2	500	400	14657
2313	N/A *1	500	FWH-700A, FWH-800A	500	*2	600	500	14657
2360	N/A *1	600	FWH-800A, FWH-1000B	600	*2	700	600	52800
2415	N/A *1	700	FWH-1000B	700	*2	800	n/a	52800

\*1 You cannot use semiconductor fuses. The UL Type 1 kit does not support internal fuses for this drive model.

\*2 Enclosure volume is not restricted. Refer to the values in "Any Size Protected Enclosure (Ventilated/Non-Ventilated)" column for details on the fuses.

## ■ Three-Phase 400 V Class

**Table 12.4 Required Short Circuit Protection**

Drive Model	Drive Mounted without Supplemental Enclosure (Using UL Type 1 Kit)		Drive Mounted in Supplemental Enclosure					
			Any Size Protected Enclosure (Ventilated/Non-Ventilated)		Restricted Size Protected Enclosure (Ventilated Only)			
	Semiconductor Fuse Manufacturer: EATON/ Bussmann (Permitted Only in UL Type 1 Kit)	Class CC, J, or T Fuse Maximum Amps (A) (Permitted in Same or Separate Enclosure)	Semiconductor Fuse Manufacturer: EATON/ Bussmann (Drive and Fuses in Same Enclosure Only)	Class CC, J, or T Fuse Maximum Amps (A) (Permitted in Same or Separate Enclosure)	These Devices Permitted in Same or Separate Enclosure			
					Class CC, J, or T Fuse Maximum Amps (A)	MCCB Maximum Amps (A)	Class RK1 or RK5 Fuse Maximum Amps (A)	Minimum Enclosure Volume (in <sup>3</sup> )
4002	N/A *1	3.5	FWH-40B, FWH-50B	3.5	*4	15	3.5	4195
4004	N/A *1	7	FWH-50B	7	*4	15	7	4195
4005	N/A *1	9	FWH-50B	9	*4	15	9	4195
4007	N/A *1	12	FWH-60B	12	*4	15	12	4195
4009	N/A *1	15	FWH-60B	15	*4	15	15	4195
4012	N/A *1	20	FWH-60B	20	*4	20	20	4195
4018	N/A *1	30	FWH-80B	30	*4	35	30	4195
4023	N/A *1	40	FWH-90B	40	*4	45	40	4195
4031	N/A *1	50	FWH-125B, FWH-150B	50	*4	60	50	4195
4038	N/A *1	60	FWH-200B	60	*4	75	60	4195
4044	N/A *1	70	FWH-200B	70	*4	80	70	4195
4060	N/A *1	100	FWH-225A	100	*4	110	100	4195
4075	N/A *1	125	FWH-250A	125	*4	150	125	10121
4089	N/A *1	150	FWH-250A, FWH-275A	150	*4	175	150	10121
4103	N/A *1	175	FWH-250A, FWH-275A	175	*4	200	175	10121
4140	N/A *1	225	FWH-300A	225	*4	250	225	10121
4168	N/A *1	250	FWH-325A, FWH-400A	250	*4	300	250	10121
4208	N/A *1	350	FWH-500A	350	*4	400	350	14657
4250	N/A *1	400	FWH-600A	400	*4	500	400	14657
4302	N/A *1	500	FWH-700A	500	*4	600	500	14657
4371	FWH-800A	N/A *2	FWH-800A	N/A *3	600	700	600	52800
4414	FWH-800A, FWH-1000B	N/A *2	FWH-800A, FWH-1000B	N/A *3	700	800	N/A	52800
4477	FWH-1000B, FWH-1200B	N/A *2	FWH-1000B, FWH-1200B	N/A *3	800	900	N/A	52800
4568	FWH-1000B, FWH-1200B	N/A *2	FWH-1000B, FWH-1200B	N/A *3	900	1000	N/A	52800
4605	FWH-1200B, FWH-1400A	N/A *2	FWH-1200B, FWH-1400A	N/A *3	1000	1200	N/A	52800
4720	FWH-1200B, FWH-1400A	N/A *2	FWH-1200B, FWH-1400A	N/A *3	1200	1400	N/A	52800

\*1 You cannot use semiconductor fuses. The UL Type 1 kit does not support internal fuses for this drive model.

\*2 You cannot use Class CC, J, or T Fuses. Use semiconductor fuses.

\*3 You cannot use Class CC, J, or T Fuses. Install the fuses into an enclosure with the necessary minimum enclosure volume.

\*4 Enclosure volume is not restricted. Refer to the values in "Any Size Protected Enclosure (Ventilated/Non-Ventilated)" column for details on the fuses.

## ◆ UL Standards Compliance for DC Power Supply Input

To comply with UL Standards, install a fuse for the DC power supply input.

Figure 12.2 shows a wiring example for a DC power supply that has two drives connected in parallel.

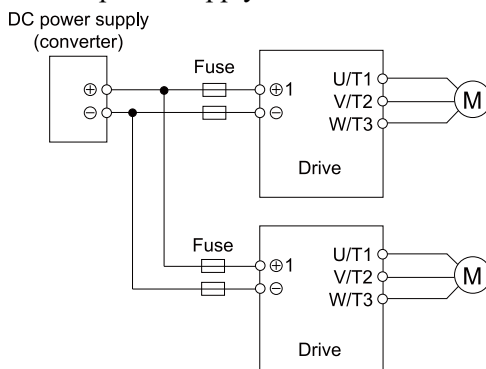

Figure 12.2 Wiring Example for DC Power Supply Input

**⚠ WARNING** Electrical Shock Hazard. Do not ground the main circuit bus. Incorrect wiring can cause serious injury or death.

**Note:**

Install a fuse for each drive when operating more than one drive. If one fuse blows, replace all fuses.

Refer to Table 12.5 and Table 12.6 for the recommended fuses.

Table 12.5 Recommended Fuse (Three-Phase 200 V Class)

Drive Model	Fuse Manufacturer: Bussmann		Drive Model	Fuse Manufacturer: Bussmann	
	Model	Qty		Model	Qty
2004	FWH-45B	2	2056	FWH-200B	2
2006	FWH-45B	2	2070	FWH-225A	2
2008	FWH-45B	2	2082	FWH-250A	2
2010	FWH-45B	2	2110	FWH-250A	2
2012	FWH-50B	2	2138	FWH-300A	2
	FWH-80B <sup>*1</sup>		2169	FWH-350A	2
	FWH-100B <sup>*1</sup>		2211	FWH-450A	2
2018	FWH-80B	2	2257	FWH-600A	2
	FWH-100B <sup>*1</sup>		2313	FWH-800A	2
2021	FWH-80B	2	2360	FWH-1000B	2
	FWH-100B <sup>*1</sup>		2415	FWH-1000B	2
2030	FWH-125B	2			
2042	FWH-150B	2			

\*1 Yaskawa recommends a fuse with a large rated current for applications with repeated loads of approximately 150%.

Table 12.6 Recommended Fuse (Three-Phase 400 V Class)

Drive Model	Fuse Manufacturer: Bussmann		Drive Model	Fuse Manufacturer: Bussmann	
	Model	Qty		Model	Qty
4002	FWP-50B	2	4018	FWP-80B	2
4004	FWP-50B	2	4023	FWP-90B	2
4005	FWP-50B	2	4031	FWP-150A	2
4007	FWP-60B	2	4038	FWP-200A	2
4009	FWP-60B	2	4044	FWP-200A	2
4012	FWP-60B	2	4060	FWP-225A	2

Drive Model	Fuse Manufacturer: Bussmann	
	Model	Qty
4075	FWP-250A	2
4089	FWP-300A	2
4103	FWP-300A	2
4140	FWP-350A	2
4168	FWP-450A	2
4208	FWP-600A	2
4250	FWP-700A	2

Drive Model	Fuse Manufacturer: Bussmann	
	Model	Qty
4302	FWP-800A	2
4371	-	-
4414	-	-
4477	-	-
4568	-	-
4605	-	-
4720	-	-

### ◆ Low Voltage Wiring for Control Circuit Terminals

You must provide low voltage wiring as specified by the National Electric Code (NEC), the Canadian Electric Code, Part I (CEC), and local codes. Yaskawa recommends the NEC class 1 circuit conductor. Use the UL approved class 2 power supply for external power supply.

**Table 12.7 Control Circuit Terminal Power Supplies**

Input/Output	Terminals	Power Supply Specifications
Digital input	S1 to S8, SN, SC, SP	Uses the LVLC power supply in the drive. Use the UL Listed class 2 power supply for external power supply.
Analog input	A1 to A3, AC, +V, -V	Uses the LVLC power supply in the drive. Use the UL Listed class 2 power supply for external power supply.
Analog output	FM, AM, AC	Uses the LVLC power supply in the drive.
Pulse train output	MP, AC	Uses the LVLC power supply in the drive. Use the UL Listed class 2 power supply for external power supply.
Pulse train input	RP, AC	Uses the LVLC power supply in the drive. Use the UL Listed class 2 power supply for external power supply.
Safe disable input	H1, H2, HC	Uses the LVLC power supply in the drive. Use the UL Listed class 2 power supply for external power supply.
Serial communication input/output	D+, D-, AC	Uses the LVLC power supply in the drive. Use the UL Listed class 2 power supply for external power supply.
24 V external power supply	PS, AC	Use the UL Listed class 2 power supply.

### ◆ Drive Motor Overload and Overheat Protection

The drive motor overload and overheat protection function complies with the National Electric Code (NEC) and the Canadian Electric Code, Part I (CEC).

Set the Motor Rated Current and L1-01 through L1-04 [Motor Overload Protection Select] correctly to enable motor overload and overheat protection.

Refer to the control method and set the motor rated current with E2-01 [Motor Rated Current (FLA)], E5-03 [PM Motor Rated Current (FLA)], or E9-06 [Motor Rated Current (FLA)].

#### ■ E2-01: Motor Rated Current (FLA)

No. (Hex.)	Name	Description	Default (Range)
E2-01 (030E)	Motor Rated Current (FLA)	<span style="border: 1px solid black; padding: 2px;">V/f</span> <span style="border: 1px solid black; padding: 2px;">CL-V/f</span> <span style="border: 1px solid black; padding: 2px;">OLV</span> <span style="border: 1px solid black; padding: 2px;">CLV</span> <span style="border: 1px solid black; padding: 2px;">AOLV</span> <span style="border: 1px solid black; padding: 2px;">OLV/PM</span> <span style="border: 1px solid black; padding: 2px;">AOLV/PM</span> <span style="border: 1px solid black; padding: 2px;">CLV/PM</span> <span style="border: 1px solid black; padding: 2px;">EZOLV</span> Sets the motor rated current in amps.	Determined by o2-04, C6-01 (10% to 200% of the drive rated current)



**Note:**

- If  $E2-01 < E2-03$  [Motor No-Load Current], the drive will detect  $oPE02$  [Parameter Range Setting Error].
- When the drive model changes, the display units for this parameter also change.
  - 0.01 A: models 2004 - 2042, 4002 - 4023
  - 0.1 A: models 2056 - 2415, 4031 - 4720

The value set for  $E2-01$  becomes the reference value for motor protection, the torque limit, and torque control. Enter the motor rated current written on the motor nameplate. Auto-Tuning the drive will automatically set  $E2-01$  to the value input for “Motor Rated Current”.

### ■ E5-03: Motor Rated Current (FLA)

No. (Hex.)	Name	Description	Default (Range)
E5-03 (032B)	Motor Rated Current (FLA)	V/f CL-V/f OLV CLV AOLV <b>OLV/PM</b> AOLV/PM CLV/PM EZOLV Sets the PM motor rated current (FLA).	Determined by E5-01 (10% to 200% of the drive rated current)

**Note:**

The display units are different for different models:

- 0.01 A: models 2004 - 2042, 4002 - 4023
- 0.1 A: models 2056 - 2415, 4031 - 4720

The drive automatically sets  $E5-03$  to the value input for “PM Motor Rated Current” after you do these types of Auto-Tuning:

- Manual Entry w/ Motor Data Sheet
- PM Stationary Auto-Tuning
- Stationary (R Only)
- Rotational (Ld, Lq, R, back-EMF)

### ■ E9-06: Motor Rated Current (FLA)

No. (Hex.)	Name	Description	Default (Range)
E9-06 (11E9)	Motor Rated Current (FLA)	V/f CL-V/f OLV CLV AOLV <b>OLV/PM</b> AOLV/PM CLV/PM <b>EZOLV</b> Sets the motor rated current in amps.	Determined by E9-01 and o2-04 (10% to 200% of the drive rated current)

**Note:**

The display units are different for different models:

- 0.01 A: models 2004 - 2042, 4002 - 4023
- 0.1 A: models 2056 - 2415, 4031 - 4720

The setting value of  $E9-06$  is the reference value for motor protection. Enter the motor rated current written on the motor nameplate. Auto-Tuning the drive will automatically set  $E9-06$  to the value input for “Motor Rated Current”.

### ■ L1-01: Motor Overload (oL1) Protection

No. (Hex.)	Name	Description	Default (Range)
L1-01 (0480)	Motor Overload (oL1) Protection	V/f CL-V/f OLV CLV AOLV <b>OLV/PM</b> AOLV/PM CLV/PM <b>EZOLV</b> Sets the motor overload protection with electronic thermal protectors.	Determined by A1-02 (0 - 6)

This parameter enables and disables the motor overload protection with electronic thermal protectors.

The cooling capability of the motor changes when the speed control range of the motor changes. Use an electronic thermal protector that aligns with the permitted load characteristics of the motor to select motor protection.

The electronic thermal protector of the drive uses these items to calculate motor overload tolerance and supply overload protection for the motor:

- Output current
- Output frequency
- Motor thermal characteristics

• Time characteristics

If the drive detects motor overload, the drive will trigger an *oL1* [Motor Overload] and stop the drive output.

Set *H2-01 = 1F* [Term *M1-M2 Function Selection = Motor Overload Alarm (oL1)*] to set a motor overload alarm. If the motor overload level is more than 90% of the *oL1* detection level, the output terminal activates and triggers an overload alarm.

**0 : Disable**

Disable motor protection when motor overload protection is not necessary or when the drive is operating more than one motor.

Refer to [Figure 12.3](#) for an example of the circuit configuration to connect more than one motor to one drive.

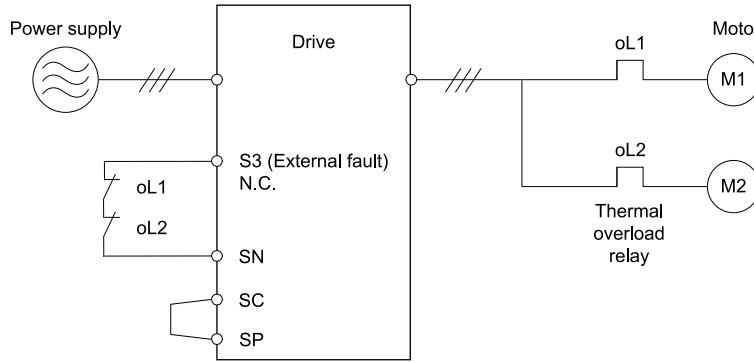

**Figure 12.3 Protection Circuit Configuration to Connect More than One Motor to One Drive**

**NOTICE** When you connect more than one motor to one drive or when the motor amp rating is higher than the drive amp rating, set *L1-01 = 0* [Motor Overload (*oL1*) Protection = Disabled] and install thermal overload relays for each motor. The electronic thermal protection of the drive will not function and it can cause damage to the motor.

**1 : Variable Torque**

Use this setting for general-purpose motors with a 60 Hz base frequency.

The overload tolerance decreases as motor speed decreases because the cooling fan speed decreases and the ability of the motor to cool decreases in the low speed range.

The overload tolerance characteristics of the motor change the trigger point for the electronic thermal protector. This provides motor overheat protection from low speed to high speed across the full speed range.

Load Tolerance	Cooling Capability	Overload Characteristics (at 100% motor load)
	<p>This motor is designed to operate with commercial line power. Operate at a 60 Hz base frequency to maximize the motor cooling ability.</p>	<p>If the motor operates at frequencies less than 60 Hz, the drive will detect <i>oL1</i>. The drive triggers a fault relay output and the motor coasts to stop.</p>

**2 : Constant Torque 10:1 Speed Range**

Use this setting for drive-dedicated motors with a speed range for constant torque of 1:10.

The speed control for this motor is 10% to 100% when at 100% load. Operating slower than 10% speed at 100% load will cause motor overload.

Load Tolerance	Cooling Capability	Overload Characteristics (at 100% motor load)
	<p>This motor is designed to withstand increased temperatures during continuous operation in the low speed range (10% base frequency).</p>	<p>The motor operates continuously at 10% to 100% base frequency. Operating slower than 10% speed at 100% load will cause motor overload.</p>

### 3 : Constant Torque 100:1 SpeedRange

Use this setting for vector motors with a speed range for constant torque of 1:100.

The speed control for this motor is 1% to 100% when at 100% load. Operating slower than 1% speed at 100% load will cause motor overload.

Load Tolerance	Cooling Capability	Overload Characteristics (at 100% motor load)
	<p>This motor is designed to withstand increased temperatures during continuous operation in the low speed range (1% base frequency).</p>	<p>The motor operates continuously at 1% to 100% base frequency. Operating slower than 1% speed at 100% load will cause motor overload.</p>

### 4 : PM Variable Torque

Use this setting for PM motors with derated torque characteristics.

The overload tolerance decreases as motor speed decreases because the cooling fan speed decreases and the ability of the motor to cool decreases in the low speed range.

The overload tolerance characteristics of the motor change the trigger point for the electronic thermal protector. This provides motor overheat protection from low speed to high speed across the full speed range.

Load Tolerance	Cooling Capability	Overload Characteristics (at 100% motor load)
	<p>This motor is designed to withstand increased temperatures during continuous operation at rated speed and rated torque.</p>	<p>If the motor operates continuously at lower speed than rated rotation speed at more than 100% torque, the drive will detect <i>oLI</i>. The drive triggers a fault relay output and the motor coasts to stop.</p>

### 5 : PM Constant Torque

Use this setting with a PM motor for constant torque that has a speed range for constant torque of 1:500.

The speed control for this motor is 0.2% to 100% when at 100% load. Operating slower than 0.2% speed at 100% load will cause motor overload.

Load Tolerance	Cooling Capability	Overload Characteristics (at 100% motor load)
	<p>This motor is designed to withstand increased temperatures during continuous operation in the low speed range (0.2% base frequency).</p>	<p>The motor operates continuously at 0.2% to 100% rated speed. Operating slower than 0.2% speed at 100% load will cause motor overload.</p>

**6 : Variable Torque (50Hz)**

Use this setting for general-purpose motors with a 50 Hz base frequency.

The overload tolerance decreases as motor speed decreases because the cooling fan speed decreases and the ability of the motor to cool decreases in the low speed range.

The overload tolerance characteristics of the motor change the trigger point for the electronic thermal protector. This provides motor overheat protection from low speed to high speed across the full speed range.

Load Tolerance	Cooling Capability	Overload Characteristics (at 100% motor load)
	<p>This motor is designed to operate with commercial line power. Operate at a 50 Hz base frequency to maximize the motor cooling ability.</p>	<p>If the motor operates at frequencies less than commercial line power, the drive will detect <i>o.L.</i>. The drive triggers a fault relay output and the motor coasts to stop.</p>

**■ L1-02: Motor Overload Protection Time**

No. (Hex.)	Name	Description	Default (Range)
L1-02 (0481)	Motor Overload Protection Time	<div style="display: flex; gap: 5px;"> <span style="border: 1px solid black; padding: 2px;">V/f</span> <span style="border: 1px solid black; padding: 2px;">CL-V/f</span> <span style="border: 1px solid black; padding: 2px;">OLV</span> <span style="border: 1px solid black; padding: 2px;">CLV</span> <span style="border: 1px solid black; padding: 2px;">AOLV</span> <span style="border: 1px solid black; padding: 2px;">OLV/PM</span> <span style="border: 1px solid black; padding: 2px;">AOLV/PM</span> <span style="border: 1px solid black; padding: 2px;">CLV/PM</span> <span style="border: 1px solid black; padding: 2px;">EZOLV</span> </div> <p>Sets the operation time for the electronic thermal protector of the drive to prevent damage to the motor. Usually it is not necessary to change this setting.</p>	1.0 min (0.1 - 5.0 min)

Set the overload tolerance time to the length of time that the motor can operate at 150% load from continuous operation at 100% load.

When the motor operates at 150% load continuously for 1 minute after continuous operation at 100% load (hot start), the default setting triggers the electronic thermal protector.

Figure 12.4 shows an example of the electronic thermal protector operation time. Motor overload protection operates in the range between a cold start and a hot start.

This example shows a general-purpose motor operating at the base frequency with L1-02 set to 1.0 min.

- Cold start  
Shows the motor protection operation time characteristics when the overload occurs immediately after starting operation from a complete stop.
- Hot start  
Shows the motor protection operation time characteristics when overload occurs from continuous operation below the motor rated current.

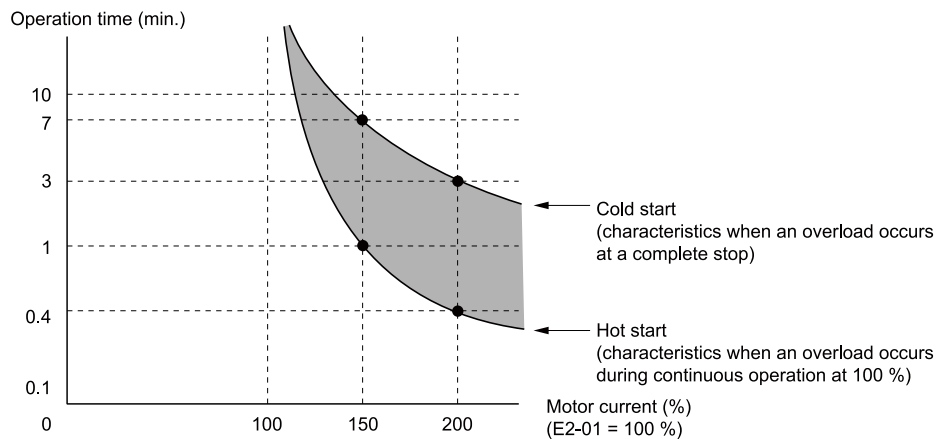

Figure 12.4 Protection Operation Time for a General-purpose Motor at Rated Output Frequency

### ■ L1-03: Motor Thermistor oH Alarm Select

No. (Hex.)	Name	Description	Default (Range)
L1-03 (0482)	Motor Thermistor oH Alarm Select	<input type="checkbox"/> V/f <input type="checkbox"/> CL-V/f <input type="checkbox"/> OLV <input type="checkbox"/> CLV <input type="checkbox"/> AOLV <input type="checkbox"/> OLV/IPM <input type="checkbox"/> AOLV/IPM <input type="checkbox"/> CLV/IPM <input type="checkbox"/> EZOLV Sets drive operation when the PTC input signal entered into the drive is at the oH3 [Motor Overheat Alarm] detection level.	3 (0 - 3)

#### 0 : Ramp to Stop

The drive ramps the motor to stop in the deceleration time. Fault relay output terminal MA-MC turns ON, and MB-MC turns OFF.

#### 1 : Coast to Stop

The output turns off and the motor coasts to stop. Fault relay output terminal MA-MC turns ON, and MB-MC turns OFF.

#### 2 : Fast Stop (Use C1-09)

The drive stops the motor in the deceleration time set in *C1-09* [Fast Stop Time]. Fault relay output terminal MA-MC turns ON, and MB-MC turns OFF.

#### 3 : Alarm Only

The keypad shows *oH3* and the drive continues operation. The output terminal set for *Alarm* [H2-01 to H2-03 = 10] activates.

### ■ L1-04: Motor Thermistor oH Fault Select

No. (Hex.)	Name	Description	Default (Range)
L1-04 (0483)	Motor Thermistor oH Fault Select	<input type="checkbox"/> V/f <input type="checkbox"/> CL-V/f <input type="checkbox"/> OLV <input type="checkbox"/> CLV <input type="checkbox"/> AOLV <input type="checkbox"/> OLV/IPM <input type="checkbox"/> AOLV/IPM <input type="checkbox"/> CLV/IPM <input type="checkbox"/> EZOLV Sets the drive operation when the PTC input signal to the drive is at the oH4 [Motor Overheat Fault (PTC Input)] detection level.	1 (0 - 2)

#### 0 : Ramp to Stop

The drive ramps the motor to stop in the deceleration time. Fault relay output terminal MA-MC turns ON, and MB-MC turns OFF.

#### 1 : Coast to Stop

The output turns OFF and the motor coasts to stop. Fault relay output terminal MA-MC turns ON, and MB-MC turns OFF.

#### 2 : Fast Stop (Use C1-09)

The drive stops the motor in the deceleration time set in *C1-09* [Fast Stop Time]. Fault relay output terminal MA-MC turns ON, and MB-MC turns OFF.

## 13 European Standards



**Figure 13.1 CE Mark**

The CE Mark identifies that the product meets environmental and safety standards in the European Union. Products manufactured, sold, or imported in the European Union must display the CE Mark.

European Union standards include standards for electrical appliances (Low Voltage Directive), standards for electrical noise (EMC Directive), and standards for machinery (Machinery Directive).

This product displays the CE Mark in accordance with the Low Voltage Directive, the EMC Directive, and the Machinery Directive.

**Table 13.1 Harmonized Standards**

European Directive	Harmonized Standards
CE Low Voltage Directive Compliance 2014/35/EU	EN 61800-5-1
EMC Directive 2014/30/EU	EN61800-3
Machinery Directive 2006/42/EC	<ul style="list-style-type: none"> <li>• EN ISO 13849-1:2015 (PL e (Cat.III))</li> <li>• IEC62061 (SILCL3)</li> <li>• EN62061 (SILCL3)</li> <li>• IEC/EN61800-5-2 (SIL3)</li> </ul>
Restriction of the use of certain hazardous substances (RoHS) 2011/65/EU	EN IEC 63000

The customer must display the CE Mark on the final device containing this product. Customers must verify that the final device complies with EU standards.

**Table 13.2 Other Applicable Standards**

European Directive	Applicable Standards
EU ErP Directive 2009/125/EC	<p>The drive meets the requirements for IE2 efficiency according to the European regulation 2019/1781.</p> <p>The losses and the efficiency class were determined in accordance with EN 61800-9-2:2017.</p>

### ◆ EU Declaration of Conformity

Go to [www.yaskawa.com](http://www.yaskawa.com) and search for “EU Declaration of Conformity” to get an original copy of the EU Declaration of Conformity.

Yaskawa declares that this product complies with the following directives and standards at our sole responsibility.

### ◆ CE Low Voltage Directive Compliance

It has been confirmed that this product complies with the CE Low Voltage Directive by conducting a test according to IEC/EN 61800-5-1:2007.

The following conditions must be satisfied for machines and devices incorporating this product to comply with the CE Low Voltage Directive.

#### ■ Area of Use

Install this product in a location with Overvoltage Category III and pollution degree 2 or less as specified in IEC/CE 60664.

## Guarding Against Debris

When you install IP20/UL Open type drives (models: 2xxxxB, 4xxxxB), use an enclosure panel that does not let unwanted material enter the drive from above or below.

## Electrical Installation

Refer to [Figure 13.2](#) for an example of a drive that is wired to comply with the CE Low Voltage Directive.

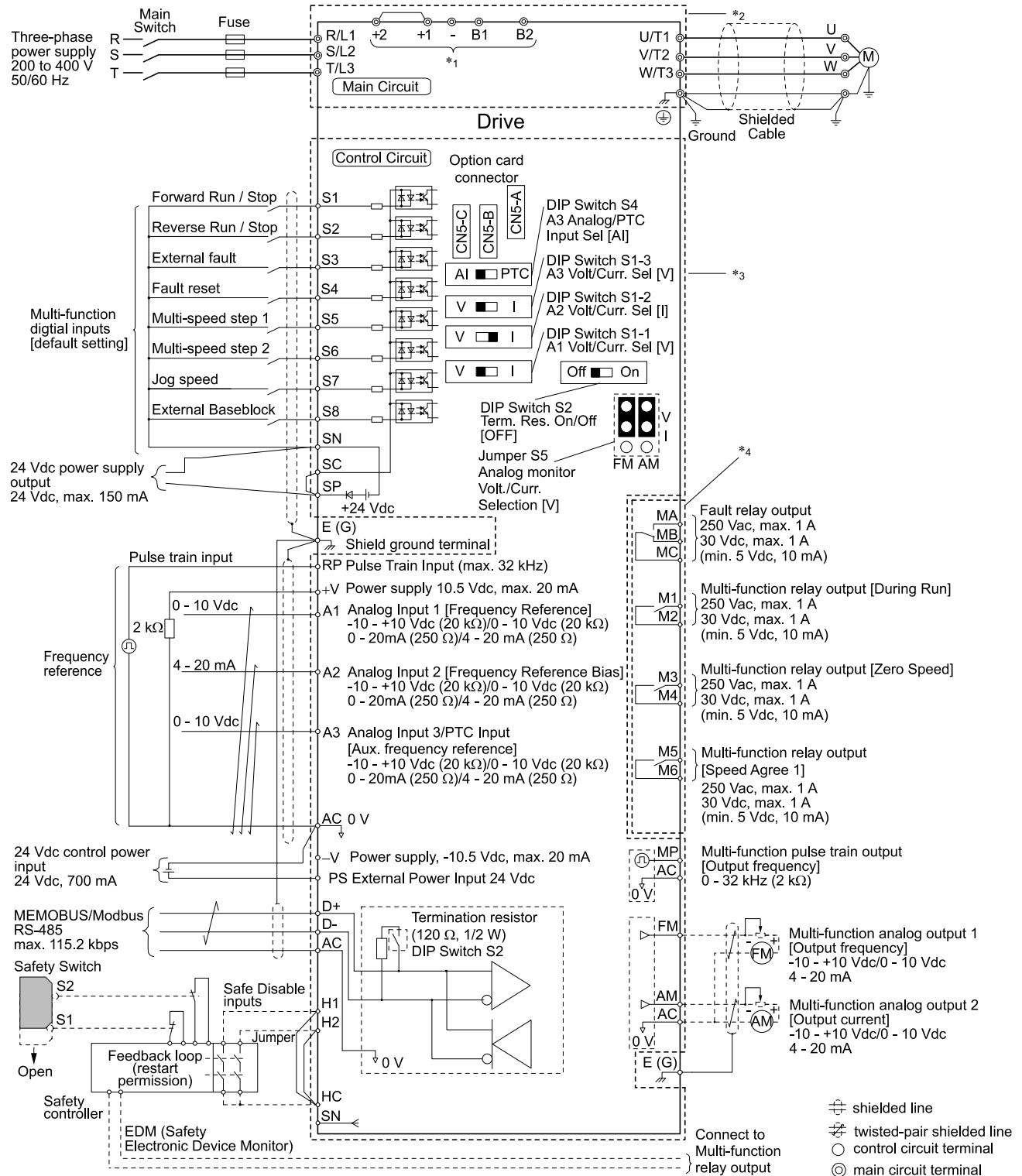

Figure 13.2 Wiring Diagram for CE Low Voltage Directive Compliance

\*1 Connect peripheral options to terminals -, +1, +2, B1, and B2.

**⚠ WARNING** *Sudden Movement Hazard. Make sure that the polarity is correct before you send a Run command. If the drive incorrectly detects the polarity, the drive can rotate in the direction opposite of the Run command and cause serious injury or death.*

\*2 To protect the circuit, the main circuit is separate from the surface case that can touch the main circuit.

\*3 The control circuit is a Safety Extra-Low Voltage circuit. Use reinforced insulation to separate this circuit from other circuits. Make sure that you connect the Safety Extra-Low Voltage as specified.

\*4 Reinforced insulation separates the output terminals from other circuits. You can also connect circuits that are not Safety Extra-Low Voltage circuits when the drive output is 250 Vac 1 A maximum or 30 Vdc 1 A maximum.

## ■ Main Circuit Wire Gauges and Tightening Torques

**⚠ WARNING** *Electrical Shock Hazard. Only connect peripheral options, for example a DC link choke or braking resistor, to terminals +1, +2, +3, -, B1, and B2. Incorrect wiring can cause serious injury or death.*

### Note:

- The recommended wire gauges are based on drive continuous current ratings with 75 °C (167 °F) 600 V class 2 heat-resistant indoor PVC wire. Assume these conditions:
  - Ambient temperature: 40 °C (104 °F) maximum
  - Wiring distance: 100 m (328 ft) maximum
  - Normal Duty rated current value
- Refer to the instruction manual for each device for recommended wire gauges to connect peripheral devices or options to terminals +1, +2, +3, -, B1, and B2. Contact Yaskawa or your nearest sales representative if the recommended wire gauges for the peripheral devices or options are out of the range of the applicable gauges for the drive.

### Three-Phase 200 V Class































Model	Terminal	Recomm. Gauge mm <sup>2</sup>	Applicable Gauge (IP20 Applicable Gauge *) mm <sup>2</sup>	Wire Stripping Length *2 mm	Terminal Screw Size and Shape	Tightening Torque N·m (lbf·in)
2004	R/L1, S/L2, T/L3	2.5	2.5 - 10 (2.5 - 10)	10	M4 ⊖	1.5 - 1.7 (13.5 - 15)
	U/T1, V/T2, W/T3	2.5	2.5 - 10 (2.5 - 10)	10	M4 ⊖	1.5 - 1.7 (13.5 - 15)
	-, +1, +2	2.5	2.5 - 16 (2.5 - 16)	18	M5 ⊖	2.3 - 2.5 (19.8 - 22) *3
	B1, B2	2.5	2.5 - 4 (2.5 - 4)	10	M4 ⊖	1.5 - 1.7 (13.5 - 15)
	⊕	2.5 *4	2.5 - 10 (-)	-	M4 ⊕	1.2 - 1.5 (10.6 - 13.3)
2006	R/L1, S/L2, T/L3	2.5	2.5 - 10 (2.5 - 10)	10	M4 ⊖	1.5 - 1.7 (13.5 - 15)
	U/T1, V/T2, W/T3	2.5	2.5 - 10 (2.5 - 10)	10	M4 ⊖	1.5 - 1.7 (13.5 - 15)
	-, +1, +2	2.5	2.5 - 16 (2.5 - 16)	18	M5 ⊖	2.3 - 2.5 (19.8 - 22) *3
	B1, B2	2.5	2.5 - 4 (2.5 - 4)	10	M4 ⊖	1.5 - 1.7 (13.5 - 15)
	⊕	2.5 *4	2.5 - 10 (-)	-	M4 ⊕	1.2 - 1.5 (10.6 - 13.3)
2008	R/L1, S/L2, T/L3	2.5	2.5 - 10 (2.5 - 10)	10	M4 ⊖	1.5 - 1.7 (13.5 - 15)
	U/T1, V/T2, W/T3	2.5	2.5 - 10 (2.5 - 10)	10	M4 ⊖	1.5 - 1.7 (13.5 - 15)
	-, +1, +2	2.5	2.5 - 16 (2.5 - 16)	18	M5 ⊖	2.3 - 2.5 (19.8 - 22) *3
	B1, B2	2.5	2.5 - 4 (2.5 - 4)	10	M4 ⊖	1.5 - 1.7 (13.5 - 15)
	⊕	2.5 *4	2.5 - 10 (-)	-	M4 ⊕	1.2 - 1.5 (10.6 - 13.3)















Model	Terminal	Recomm. Gauge mm <sup>2</sup>	Applicable Gauge (IP20 Applicable Gauge *) mm <sup>2</sup>	Wire Stripping Length* <sup>2</sup> mm	Terminal Screw Size and Shape	Tightening Torque N·m (lbf·in)
2010	R/L1, S/L2, T/L3	2.5	2.5 - 10 (2.5 - 10)	10	M4 ⊖	1.5 - 1.7 (13.5 - 15)
	U/T1, V/T2, W/T3	2.5	2.5 - 10 (2.5 - 10)	10	M4 ⊖	1.5 - 1.7 (13.5 - 15)
	-, +1, +2	2.5	2.5 - 16 (2.5 - 16)	18	M5 ⊖	2.3 - 2.5 (19.8 - 22) * <sup>3</sup>
	B1, B2	2.5	2.5 - 4 (2.5 - 4)	10	M4 ⊖	1.5 - 1.7 (13.5 - 15)
	⊕	2.5 * <sup>4</sup>	2.5 - 10 (-)	-	M4 ⊕	1.2 - 1.5 (10.6 - 13.3)
2012	R/L1, S/L2, T/L3	2.5	2.5 - 10 (2.5 - 10)	10	M4 ⊖	1.5 - 1.7 (13.5 - 15)
	U/T1, V/T2, W/T3	2.5	2.5 - 10 (2.5 - 10)	10	M4 ⊖	1.5 - 1.7 (13.5 - 15)
	-, +1, +2	2.5	2.5 - 16 (2.5 - 16)	18	M5 ⊖	2.3 - 2.5 (19.8 - 22) * <sup>3</sup>
	B1, B2	2.5	2.5 - 4 (2.5 - 4)	10	M4 ⊖	1.5 - 1.7 (13.5 - 15)
	⊕	2.5 * <sup>4</sup>	2.5 - 10 (-)	-	M4 ⊕	1.2 - 1.5 (10.6 - 13.3)
2018	R/L1, S/L2, T/L3	2.5	2.5 - 10 (2.5 - 10)	10	M4 ⊖	1.5 - 1.7 (13.5 - 15)
	U/T1, V/T2, W/T3	2.5	2.5 - 10 (2.5 - 10)	10	M4 ⊖	1.5 - 1.7 (13.5 - 15)
	-, +1, +2	4	2.5 - 16 (2.5 - 16)	18	M5 ⊖	2.3 - 2.5 (19.8 - 22) * <sup>3</sup>
	B1, B2	2.5	2.5 - 4 (2.5 - 4)	10	M4 ⊖	1.5 - 1.7 (13.5 - 15)
	⊕	2.5 * <sup>4</sup>	2.5 - 10 (-)	-	M4 ⊕	1.2 - 1.5 (10.6 - 13.3)
2021	R/L1, S/L2, T/L3	6	2.5 - 10 (2.5 - 10)	10	M4 ⊖	1.5 - 1.7 (13.5 - 15)
	U/T1, V/T2, W/T3	2.5	2.5 - 10 (2.5 - 10)	10	M4 ⊖	1.5 - 1.7 (13.5 - 15)
	-, +1, +2	6	2.5 - 16 (2.5 - 16)	18	M5 ⊖	2.3 - 2.5 (19.8 - 22) * <sup>3</sup>
	B1, B2	2.5	2.5 - 4 (2.5 - 4)	10	M4 ⊖	1.5 - 1.7 (13.5 - 15)
	⊕	6 * <sup>4</sup>	4 - 10 (-)	-	M4 ⊕	1.2 - 1.5 (10.6 - 13.3)
2030	R/L1, S/L2, T/L3	10	2.5 - 10 (2.5 - 10)	10	M4 ⊖	1.5 - 1.7 (13.5 - 15)
	U/T1, V/T2, W/T3	6	2.5 - 10 (2.5 - 10)	10	M4 ⊖	1.5 - 1.7 (13.5 - 15)
	-, +1, +2	10	2.5 - 16 (2.5 - 16)	18	M5 ⊖	2.3 - 2.5 (19.8 - 22) * <sup>3</sup>
	B1, B2	2.5	2.5 - 4 (2.5 - 4)	10	M4 ⊖	1.5 - 1.7 (13.5 - 15)
	⊕	10	6 - 10 (-)	-	M5 ⊕	2.0 - 2.5 (17.7 - 22.1)

# 13 European Standards













Model	Terminal	Recomm. Gauge mm <sup>2</sup>	Applicable Gauge (IP20 Applicable Gauge *) mm <sup>2</sup>	Wire Stripping Length *2 mm	Terminal Screw Size and Shape	Tightening Torque N·m (lbf·in)
2042	R/L1, S/L2, T/L3	10	2.5 - 10 (2.5 - 10)	10	M4 ⊖	1.5 - 1.7 (13.5 - 15)
	U/T1, V/T2, W/T3	10	2.5 - 10 (2.5 - 10)	10	M4 ⊖	1.5 - 1.7 (13.5 - 15)
	-, +1, +2	16	2.5 - 16 (2.5 - 16)	18	M5 ⊖	2.3 - 2.5 (19.8 - 22) *3
	B1, B2	4	2.5 - 4 (2.5 - 4)	10	M4 ⊖	1.5 - 1.7 (13.5 - 15)
	⊕	10	6 - 10 (-)	-	M5 ⊕	2.0 - 2.5 (17.7 - 22.1)
2056	R/L1, S/L2, T/L3	25	2.5 - 25 (10 - 25)	18	M5 ⊖	2.3 - 2.5 (19.8 - 22) *3
	U/T1, V/T2, W/T3	16	2.5 - 16 (6 - 16)	18	M5 ⊖	2.3 - 2.5 (19.8 - 22) *3
	-, +1, +2	35	2.5 - 35 (10 - 35)	20	M6 ⊕	5 - 5.5 (45 - 49)
	B1, B2	10	2.5 - 10 (2.5 - 10)	10	M4 ⊖	1.5 - 1.7 (13.5 - 15)
	⊕	16	10 - 16 (-)	-	M6 ⊕	5.4 - 6.0 (47.8 - 53.1)
2070	R/L1, S/L2, T/L3	35	2.5 - 35 (25 - 35)	20	M6 ⊕	5 - 5.5 (45 - 49)
	U/T1, V/T2, W/T3	16	2.5 - 16 (16)	20	M6 ⊕	5 - 5.5 (45 - 49)
	-, +1, +2	50	2.5 - 50 (35 - 50)	20	M6 ⊕	5 - 5.5 (45 - 49)
	B1, B2	10	2.5 - 10 (2.5 - 10)	10	M4 ⊖	1.5 - 1.7 (13.5 - 15)
	⊕	16	16 - 25 (-)	-	M6 ⊕	5.4 - 6.0 (47.8 - 53.1)
2082	R/L1, S/L2, T/L3	35	2.5 - 35 (25 - 35)	20	M6 ⊕	5 - 5.5 (45 - 49)
	U/T1, V/T2, W/T3	25	2.5 - 25 (16 - 25)	20	M6 ⊕	5 - 5.5 (45 - 49)
	-, +1, +2	50	2.5 - 50 (35 - 50)	20	M6 ⊕	5 - 5.5 (45 - 49)
	B1, B2	16	2.5 - 16 (2.5 - 16)	10	M4 ⊖	1.5 - 1.7 (13.5 - 15)
	⊕	16	16 - 25 (-)	-	M6 ⊕	5.4 - 6.0 (47.8 - 53.1)
2110	R/L1, S/L2, T/L3	35	16 - 35 (25 - 35)	27	M6 ⊕	8 - 9 (71 - 80)
	U/T1, V/T2, W/T3	35	16 - 35 (25 - 35)	27	M6 ⊕	8 - 9 (71 - 80)
	-, +1	50	25 - 50 (25 - 50)	27	M8 ⊕	10 - 12 (89 - 107)
	B1, B2	25	6 - 25 (6 - 25)	21	M6 ⊖	3 - 3.5 (27 - 31)
	⊕	16	16 - 25 (-)	-	M6 ⊕	5.4 - 6.0 (47.8 - 53.1)

Model	Terminal	Recomm. Gauge mm <sup>2</sup>	Applicable Gauge (IP20 Applicable Gauge *) mm <sup>2</sup>	Wire Stripping Length *2 mm	Terminal Screw Size and Shape	Tightening Torque N·m (lbf·in)
2138	R/L1, S/L2, T/L3	50	16 - 50 (50)	27	M6 	8 - 9 (71 - 80)
	U/T1, V/T2, W/T3	50	16 - 50 (50)	27	M6 	8 - 9 (71 - 80)
	-, +1	70	25 - 70 (50 - 70)	27	M8 	10 - 12 (89 - 107)
	B1, B2	35	6 - 35 (6 - 35)	21	M6 	3 - 3.5 (27 - 31)
		25	25 (-)	-	M6 	5.4 - 6.0 (47.8 - 53.1)
2169	R/L1, S/L2, T/L3	70	50 - 95 (95)	37	M10 	12 - 14 (107 - 124)
	U/T1, V/T2, W/T3	70	50 - 95 (95)	37	M10 	12 - 14 (107 - 124)
	-, -, +1, +1 *5 *6	35	16 - 50 (50)	28	M6 	8 - 9 (71 - 80)
	+3 *6	50	25 - 70 (50 - 70)	28	M8 	8 - 9 (71 - 80)
		35	25 - 50 (-)	-	M8 	9.0 - 11 (79.7 - 97.4)
2211	R/L1, S/L2, T/L3	95	50 - 95 (95)	37	M10 	12 - 14 (107 - 124)
	U/T1, V/T2, W/T3	95	50 - 95 (95)	37	M10 	12 - 14 (107 - 124)
	-, -, +1, +1 *5 *6	50	16 - 50 (50)	28	M6 	8 - 9 (71 - 80)
	+3 *6	70	25 - 70 (50 - 70)	28	M8 	8 - 9 (71 - 80)
		50	25 - 50 (-)	-	M8 	9.0 - 11 (79.7 - 97.4)
2257	R/L1, S/L2, T/L3	50 × 2P	25 - 95 × 2P (70 - 95 × 2P)	-	M10 	20 (177)
	U/T1, V/T2, W/T3	50 × 2P	25 - 95 × 2P (70 - 95 × 2P)	-	M10 	20 (177)
	-, +1	70 × 2P	35 - 120 × 2P (120 × 2P)	-	M10 	20 (177)
	+3	35 × 2P	25 - 70 × 2P (70 × 2P)	-	M10 	20 (177)
		95	95 - 240 (-)	-	M10 	18 - 23 (159 - 204)
2313	R/L1, S/L2, T/L3	70 × 2P	25 - 95 × 2P (70 - 95 × 2P)	-	M10 	20 (177)
	U/T1, V/T2, W/T3	70 × 2P	25 - 95 × 2P (70 - 95 × 2P)	-	M10 	20 (177)
	-, +1	95 × 2P	35 - 120 × 2P (120 × 2P)	-	M10 	20 (177)
	+3	50 × 2P	25 - 70 × 2P (70 × 2P)	-	M10 	20 (177)
		95	95 - 240 (-)	-	M10 	18 - 23 (159 - 204)

Model	Terminal	Recomm. Gauge mm <sup>2</sup>	Applicable Gauge (IP20 Applicable Gauge <sup>*1</sup> ) mm <sup>2</sup>	Wire Stripping Length <sup>*2</sup> mm	Terminal Screw Size and Shape	Tightening Torque N·m (lbf·in)
2360	R/L1, S/L2, T/L3	120 × 2P	70 - 150 × 2P (150 × 2P)	-	M12 	35 (310)
	U/T1, V/T2, W/T3	120 × 2P	70 - 150 × 2P (150 × 2P)	-	M12 	35 (310)
	-, +1	120 × 2P	95 - 185 × 2P (185 × 2P)	-	M12 	35 (310)
	+3	70 × 2P	50 - 95 × 2P (-)	-	M12 	35 (310)
		120	120 - 240 (-)	-	M12 	32 - 40 (283 - 354)
2415	R/L1, S/L2, T/L3	120 × 2P	70 - 150 × 2P (150 × 2P)	-	M12 	35 (310)
	U/T1, V/T2, W/T3	120 × 2P	70 - 150 × 2P (150 × 2P)	-	M12 	35 (310)
	-, +1	120 × 2P	95 - 185 × 2P (185 × 2P)	-	M12 	35 (310)
	+3	70 × 2P	50 - 95 × 2P (-)	-	M12 	35 (310)
		120	120 - 240 (-)	-	M12 	32 - 40 (283 - 354)

- \*1 For IP20 protection, use wires that are in the range of applicable gauges.
- \*2 Remove insulation from the ends of wires to expose the length of wire shown.
- \*3 For wire gauges more than 30 mm<sup>2</sup>, tighten to a tightening torque of 4.1 N·m to 4.5 N·m (36 lbf·in to 40 lbf·in).
- \*4 Install a GFCI with this wire gauge to maintain compliance with IEC/EN 61800-5-1:2007.
- \*5 Terminals - and +1 have two screws. The Recommended Gauge is the wire gauge for one terminal.
- \*6 A junction terminal is necessary to connect a braking unit (CDBR-series) to terminals - and +3.































**Three-Phase 400 V Class**

Model	Terminal	Recomm. Gauge mm <sup>2</sup>	Applicable Gauge (IP20 Applicable Gauge <sup>*1</sup> ) mm <sup>2</sup>	Wire Stripping Length <sup>*2</sup> mm	Terminal Screw Size and Shape	Tightening Torque N·m (lbf·in)
4002	R/L1, S/L2, T/L3	2.5	2.5 - 10 (2.5 - 10)	10	M4 	1.5 - 1.7 (13.5 - 15)
	U/T1, V/T2, W/T3	2.5	2.5 - 10 (2.5 - 10)	10	M4 	1.5 - 1.7 (13.5 - 15)
	-, +1, +2	2.5	2.5 - 16 (2.5 - 16)	18	M5 	2.3 - 2.5 (19.8 - 22) <sup>*3</sup>
	B1, B2	2.5	2.5 - 4 (2.5 - 4)	10	M4 	1.5 - 1.7 (13.5 - 15)
		2.5 <sup>*4</sup>	2.5 - 10 (-)	-	M4 	1.2 - 1.5 (10.6 - 13.3)
4004	R/L1, S/L2, T/L3	2.5	2.5 - 10 (2.5 - 10)	10	M4 	1.5 - 1.7 (13.5 - 15)
	U/T1, V/T2, W/T3	2.5	2.5 - 10 (2.5 - 10)	10	M4 	1.5 - 1.7 (13.5 - 15)
	-, +1, +2	2.5	2.5 - 16 (2.5 - 16)	18	M5 	2.3 - 2.5 (19.8 - 22) <sup>*3</sup>
	B1, B2	2.5	2.5 - 4 (2.5 - 4)	10	M4 	1.5 - 1.7 (13.5 - 15)
		2.5 <sup>*4</sup>	2.5 - 10 (-)	-	M4 	1.2 - 1.5 (10.6 - 13.3)

























Model	Terminal	Recomm. Gauge mm <sup>2</sup>	Applicable Gauge (IP20 Applicable Gauge *) mm <sup>2</sup>	Wire Stripping Length *2 mm	Terminal Screw Size and Shape	Tightening Torque N·m (lbf·in)
4005	R/L1, S/L2, T/L3	2.5	2.5 - 10 (2.5 - 10)	10	M4 ⊖	1.5 - 1.7 (13.5 - 15)
	U/T1, V/T2, W/T3	2.5	2.5 - 10 (2.5 - 10)	10	M4 ⊖	1.5 - 1.7 (13.5 - 15)
	-, +1, +2	2.5	2.5 - 16 (2.5 - 16)	18	M5 ⊖	2.3 - 2.5 (19.8 - 22) *3
	B1, B2	2.5	2.5 - 4 (2.5 - 4)	10	M4 ⊖	1.5 - 1.7 (13.5 - 15)
	⊕	2.5 *4	2.5 - 10 (-)	-	M4 ⊕	1.2 - 1.5 (10.6 - 13.3)
4007	R/L1, S/L2, T/L3	2.5	2.5 - 10 (2.5 - 10)	10	M4 ⊖	1.5 - 1.7 (13.5 - 15)
	U/T1, V/T2, W/T3	2.5	2.5 - 10 (2.5 - 10)	10	M4 ⊖	1.5 - 1.7 (13.5 - 15)
	-, +1, +2	2.5	2.5 - 16 (2.5 - 16)	18	M5 ⊖	2.3 - 2.5 (19.8 - 22) *3
	B1, B2	2.5	2.5 - 4 (2.5 - 4)	10	M4 ⊖	1.5 - 1.7 (13.5 - 15)
	⊕	2.5 *4	2.5 - 10 (-)	-	M4 ⊕	1.2 - 1.5 (10.6 - 13.3)
4009	R/L1, S/L2, T/L3	2.5	2.5 - 10 (2.5 - 10)	10	M4 ⊖	1.5 - 1.7 (13.5 - 15)
	U/T1, V/T2, W/T3	2.5	2.5 - 10 (2.5 - 10)	10	M4 ⊖	1.5 - 1.7 (13.5 - 15)
	-, +1, +2	2.5	2.5 - 16 (2.5 - 16)	18	M5 ⊖	2.3 - 2.5 (19.8 - 22) *3
	B1, B2	2.5	2.5 - 4 (2.5 - 4)	10	M4 ⊖	1.5 - 1.7 (13.5 - 15)
	⊕	2.5 *4	2.5 - 10 (-)	-	M4 ⊕	1.2 - 1.5 (10.6 - 13.3)
4012	R/L1, S/L2, T/L3	2.5	2.5 - 10 (2.5 - 10)	10	M4 ⊖	1.5 - 1.7 (13.5 - 15)
	U/T1, V/T2, W/T3	2.5	2.5 - 10 (2.5 - 10)	10	M4 ⊖	1.5 - 1.7 (13.5 - 15)
	-, +1, +2	2.5	2.5 - 16 (2.5 - 16)	18	M5 ⊖	2.3 - 2.5 (19.8 - 22) *3
	B1, B2	2.5	2.5 - 4 (2.5 - 4)	10	M4 ⊖	1.5 - 1.7 (13.5 - 15)
	⊕	2.5 *4	2.5 - 10 (-)	-	M4 ⊕	1.2 - 1.5 (10.6 - 13.3)
4018	R/L1, S/L2, T/L3	2.5	2.5 - 10 (2.5 - 10)	10	M4 ⊖	1.5 - 1.7 (13.5 - 15)
	U/T1, V/T2, W/T3	2.5	2.5 - 10 (2.5 - 10)	10	M4 ⊖	1.5 - 1.7 (13.5 - 15)
	-, +1, +2	4	2.5 - 16 (2.5 - 16)	18	M5 ⊖	2.3 - 2.5 (19.8 - 22) *3
	B1, B2	2.5	2.5 - 4 (2.5 - 4)	10	M4 ⊖	1.5 - 1.7 (13.5 - 15)
	⊕	2.5 *4	2.5 - 10 (-)	-	M5 ⊕	2.0 - 2.5 (17.7 - 22.1)

Model	Terminal	Recomm. Gauge mm <sup>2</sup>	Applicable Gauge (IP20 Applicable Gauge *) mm <sup>2</sup>	Wire Stripping Length *2 mm	Terminal Screw Size and Shape	Tightening Torque N·m (lb·in)
4023	R/L1, S/L2, T/L3	6	2.5 - 10 (2.5 - 10)	10	M4 ⊖	1.5 - 1.7 (13.5 - 15)
	U/T1, V/T2, W/T3	4	2.5 - 10 (2.5 - 10)	10	M4 ⊖	1.5 - 1.7 (13.5 - 15)
	-, +1, +2	6	2.5 - 16 (2.5 - 16)	18	M5 ⊖	2.3 - 2.5 (19.8 - 22) *3
	B1, B2	2.5	2.5 - 4 (2.5 - 4)	10	M4 ⊖	1.5 - 1.7 (13.5 - 15)
	⊕	6 *4	4 - 10 (-)	-	M5 ⊕	2.0 - 2.5 (17.7 - 22.1)
4031	R/L1, S/L2, T/L3	10	2.5 - 25 (10 - 25)	18	M5 ⊖	2.3 - 2.5 (19.8 - 22) *3
	U/T1, V/T2, W/T3	6	2.5 - 16 (6 - 16)	18	M5 ⊖	2.3 - 2.5 (19.8 - 22) *3
	-, +1, +2	10	2.5 - 35 (10 - 35)	20	M6 ⊕	5 - 5.5 (45 - 49)
	B1, B2	2.5	2.5 - 10 (2.5 - 10)	10	M4 ⊖	1.5 - 1.7 (13.5 - 15)
	⊕	10	6 - 16 (-)	-	M6 ⊕	5.4 - 6.0 (47.8 - 53.1)
4038	R/L1, S/L2, T/L3	10	2.5 - 25 (10 - 25)	18	M5 ⊖	2.3 - 2.5 (19.8 - 22) *3
	U/T1, V/T2, W/T3	6	2.5 - 16 (6 - 16)	18	M5 ⊖	2.3 - 2.5 (19.8 - 22) *3
	-, +1, +2	16	2.5 - 35 (10 - 35)	20	M6 ⊕	5 - 5.5 (45 - 49)
	B1, B2	4	2.5 - 10 (2.5 - 10)	10	M4 ⊖	1.5 - 1.7 (13.5 - 15)
	⊕	10	6 - 16 (-)	-	M6 ⊕	5.4 - 6.0 (47.8 - 53.1)
4044	R/L1, S/L2, T/L3	16	2.5 - 16 (4 - 16)	18	M5 ⊖	2.3 - 2.5 (19.8 - 22) *3
	U/T1, V/T2, W/T3	10	2.5 - 10 (6 - 10)	18	M5 ⊖	2.3 - 2.5 (19.8 - 22) *3
	-, +1, +2	25	2.5 - 25 (6 - 25)	18	M5 ⊖	2.3 - 2.5 (19.8 - 22) *3
	B1, B2	6	2.5 - 6 (2.5 - 6)	10	M4 ⊖	1.5 - 1.7 (13.5 - 15)
	⊕	16	10 - 25 (-)	-	M6 ⊕	5.4 - 6.0 (47.8 - 53.1)
4060	R/L1, S/L2, T/L3	16	2.5 - 16 (4 - 16)	18	M5 ⊖	2.3 - 2.5 (19.8 - 22) *3
	U/T1, V/T2, W/T3	16	2.5 - 16 (6 - 16)	18	M5 ⊖	2.3 - 2.5 (19.8 - 22) *3
	-, +1	25	2.5 - 25 (6 - 25)	18	M5 ⊖	2.3 - 2.5 (19.8 - 22) *3
	B1, B2	10	2.5 - 10 (2.5 - 10)	10	M4 ⊖	1.5 - 1.7 (13.5 - 15)
	⊕	16	10 - 25 (-)	-	M6 ⊕	5.4 - 6.0 (47.8 - 53.1)

Model	Terminal	Recomm. Gauge mm <sup>2</sup>	Applicable Gauge (IP20 Applicable Gauge *) mm <sup>2</sup>	Wire Stripping Length *2 mm	Terminal Screw Size and Shape	Tightening Torque N·m (lbf·in)
4075	R/L1, S/L2, T/L3	25	2.5 - 25 (2.5 - 25)	18	M5	2.3 - 2.5 (19.8 - 22) *3
	U/T1, V/T2, W/T3	25	2.5 - 25 (2.5 - 25)	18	M5	2.3 - 2.5 (19.8 - 22) *3
	-, +1	25	2.5 - 25 (4 - 25)	18	M5	2.3 - 2.5 (19.8 - 22) *3
	B1, B2	10	2.5 - 10 (2.5 - 10)	10	M4	1.5 - 1.7 (13.5 - 15)
		16	16 - 25 (-)	-	M6	5.4 - 6.0 (47.8 - 53.1)
4089	R/L1, S/L2, T/L3	25	2.5 - 25 (10 - 25)	18	M5	2.3 - 2.5 (19.8 - 22) *3
	U/T1, V/T2, W/T3	25	2.5 - 25 (10 - 25)	18	M5	2.3 - 2.5 (19.8 - 22) *3
	-, +1	35	2.5 - 35 (16 - 35)	20	M6	5 - 5.5 (45 - 49)
	B1, B2	16	2.5 - 16 (4 - 16)	18	M5	2.3 - 2.5 (19.8 - 22) *3
		16	16 - 25 (-)	-	M6	5.4 - 6.0 (47.8 - 53.1)
4103	R/L1, S/L2, T/L3	35	16 - 50 (50)	27	M6	8 - 9 (71 - 80)
	U/T1, V/T2, W/T3	35	16 - 50 (50)	27	M6	8 - 9 (71 - 80)
	-, +1	50	25 - 70 (50 - 70)	27	M8	10 - 12 (89 - 107)
	B1, B2	25	6 - 35 (6 - 35)	21	M6	3 - 3.5 (27 - 31)
		16	16 - 25 (-)	-	M6	5.4 - 6.0 (47.8 - 53.1)
4140	R/L1, S/L2, T/L3	50	50 - 95 (95)	37	M10	12 - 14 (107 - 124)
	U/T1, V/T2, W/T3	50	50 - 95 (95)	37	M10	12 - 14 (107 - 124)
	-, -, +1, +1 *5	25	16 - 50 (50)	28	M6	8 - 9 (71 - 80)
	B1, B2 *6	50	25 - 70 (50 - 70)	28	M8	8 - 9 (71 - 80)
		25	25 - 50 (-)	-	M8	9.0 - 11 (79.7 - 97.4)
4168	R/L1, S/L2, T/L3	70	50 - 95 (95)	37	M10	12 - 14 (107 - 124)
	U/T1, V/T2, W/T3	70	50 - 95 (95)	37	M10	12 - 14 (107 - 124)
	-, -, +1, +1 *5	35	16 - 50 (50)	28	M6	8 - 9 (71 - 80)
	B1, B2 *6	50	25 - 70 (50 - 70)	28	M8	8 - 9 (71 - 80)
		35	25 - 50 (-)	-	M8	9.0 - 11 (79.7 - 97.4)

Model	Terminal	Recomm. Gauge mm <sup>2</sup>	Applicable Gauge (IP20 Applicable Gauge *) mm <sup>2</sup>	Wire Stripping Length *2 mm	Terminal Screw Size and Shape	Tightening Torque N·m (lbf·in)
4208	R/L1, S/L2, T/L3	50 × 2P	25 - 95 × 2P (70 - 95 × 2P)	-	M10 	20 (177)
	U/T1, V/T2, W/T3	50 × 2P	25 - 95 × 2P (70 - 95 × 2P)	-	M10 	20 (177)
	-, +1	70 × 2P	35 - 120 × 2P (120 × 2P)	-	M10 	20 (177)
	+3	35 × 2P	25 - 70 × 2P (70 × 2P)	-	M10 	20 (177)
		50	50 - 240 (-)	-	M10 	18 - 23 (159 - 204)
4250	R/L1, S/L2, T/L3	50 × 2P	25 - 95 × 2P (70 - 95 × 2P)	-	M10 	20 (177)
	U/T1, V/T2, W/T3	50 × 2P	25 - 95 × 2P (70 - 95 × 2P)	-	M10 	20 (177)
	-, +1	70 × 2P	35 - 120 × 2P (120 × 2P)	-	M10 	20 (177)
	+3	50 × 2P	25 - 70 × 2P (70 × 2P)	-	M10 	20 (177)
		70	70 - 240 (-)	-	M10 	18 - 23 (159 - 204)
4302	R/L1, S/L2, T/L3	70 × 2P	25 - 95 × 2P (70 - 95 × 2P)	-	M10 	20 (177)
	U/T1, V/T2, W/T3	70 × 2P	25 - 95 × 2P (70 - 95 × 2P)	-	M10 	20 (177)
	-, +1	95 × 2P	35 - 120 × 2P (120 × 2P)	-	M10 	20 (177)
	+3	70 × 2P	25 - 70 × 2P (70 × 2P)	-	M10 	20 (177)
		95	95 - 240 (-)	-	M10 	18 - 23 (159 - 204)
4371	R/L1, S/L2, T/L3	120 × 2P	70 - 150 × 2P (150 × 2P)	-	M12 	35 (310)
	U/T1, V/T2, W/T3	120 × 2P	70 - 150 × 2P (150 × 2P)	-	M12 	35 (310)
	-, +1	120 × 2P	95 - 185 × 2P (185 × 2P)	-	M12 	35 (310)
	+3	70 × 2P	50 - 95 × 2P (-)	-	M12 	35 (310)
		120	120 - 240 (-)	-	M12 	32 - 40 (283 - 354)
4414	R/L1, S/L2, T/L3	120 × 2P	70 - 150 × 2P (150 × 2P)	-	M12 	35 (310)
	U/T1, V/T2, W/T3	120 × 2P	70 - 150 × 2P (150 × 2P)	-	M12 	35 (310)
	-, +1	120 × 2P	95 - 185 × 2P (185 × 2P)	-	M12 	35 (310)
	+3	95 × 2P	50 - 95 × 2P (-)	-	M12 	35 (310)
		95	35 - 240 (-)	-	M12 	32 - 40 (283 - 354)



Model	Terminal	Recomm. Gauge mm <sup>2</sup>	Applicable Gauge (IP20 Applicable Gauge *) mm <sup>2</sup>	Wire Stripping Length <sup>*2</sup> mm	Terminal Screw Size and Shape	Tightening Torque N·m (lbf·in)
4477	R/L1, S/L2, T/L3	120 × 4P	70 - 150 × 4P (150 × 4P)	-	M12 	35 (310)
	U/T1, V/T2, W/T3	95 × 4P	70 - 150 × 4P (120 - 150 × 4P)	-	M12 	35 (310)
	-, +1	95 × 4P	95 - 185 × 4P (185 × 4P)	-	M12 	35 (310)
	+3	70 × 4P	35 - 95 × 4P (95 × 4P)	-	M12 	35 (310)
		150	50 - 150 (-)	-	M12 	32 - 40 (283 - 354)
4568	R/L1, S/L2, T/L3	120 × 4P	70 - 150 × 4P (150 × 4P)	-	M12 	35 (310)
	U/T1, V/T2, W/T3	95 × 4P	70 - 150 × 4P (120 - 150 × 4P)	-	M12 	35 (310)
	-, +1	95 × 4P	95 - 185 × 4P (185 × 4P)	-	M12 	35 (310)
	+3	70 × 4P	35 - 95 × 4P (95 × 4P)	-	M12 	35 (310)
		95 × 2P	60 - 150 (-)	-	M12 	32 - 40 (283 - 354)
4605	R/L1, S/L2, T/L3	120 × 4P	70 - 150 × 4P (150 × 4P)	-	M12 	35 (310)
	U/T1, V/T2, W/T3	95 × 4P	70 - 150 × 4P (120 - 150 × 4P)	-	M12 	35 (310)
	-, +1	95 × 4P	95 - 185 × 4P (185 × 4P)	-	M12 	35 (310)
	+3	70 × 4P	35 - 95 × 4P (95 × 4P)	-	M12 	35 (310)
		95 × 2P	60 - 150 (-)	-	M12 	32 - 40 (283 - 354)
4720	R/L1, S/L2, T/L3	120 × 4P	70 - 150 × 4P (150 × 4P)	-	M12 	35 (310)
	U/T1, V/T2, W/T3	95 × 4P	70 - 150 × 4P (120 - 150 × 4P)	-	M12 	35 (310)
	-, +1	95 × 4P	95 - 185 × 4P (185 × 4P)	-	M12 	35 (310)
	+3	70 × 4P	35 - 95 × 4P (95 × 4P)	-	M12 	35 (310)
		95 × 2P	60 - 150 (-)	-	M12 	32 - 40 (283 - 354)

\*1 For IP20 protection, use wires that are in the range of applicable gauges.

\*2 Remove insulation from the ends of wires to expose the length of wire shown.

\*3 For wire gauges more than 30 mm<sup>2</sup>, tighten to a tightening torque of 4.1 N·m to 4.5 N·m (36 lbf·in to 40 lbf·in).

\*4 Install a GFCI with this wire gauge to maintain compliance with IEC/EN 61800-5-1:2007.

\*5 Terminals - and +1 have two screws. The Recommended Gauge is the wire gauge for one terminal.

\*6 A junction terminal is necessary to connect a braking resistor unit (LKEB-series) to terminals B1 and B2.

## ■ Connect a Fuse to the Input Side (Primary Side)

The drive circuit protection must comply with IEC/EN 61800-5-1 for protection against a short circuit in the internal circuitry. Yaskawa recommends connecting semiconductor protection fuses on the input side for branch circuit protection.

**⚠ WARNING** *Electrical Shock Hazard. After the drive blows a fuse or trips a GFCI, do not immediately energize the drive or operate peripheral devices. Wait for the time specified on the warning label at a minimum and make sure that all indicators are OFF. Then check the wiring and peripheral device ratings to find the cause of the problem. If you do not know the cause of the problem, contact Yaskawa before you energize the drive or peripheral devices. If you do not fix the problem before you operate the drive or peripheral devices, it can cause serious injury or death.*

### Three-Phase 200 V Class

**Table 13.3 Factory-Recommended Branch Circuit Protection (200 V Class)**

Drive Model	Semiconductor Protection Fuse Model Manufacturer: EATON/Bussmann	Drive Model	Semiconductor Protection Fuse Model Manufacturer: EATON/Bussmann
2004	FWH-45B	2082	FWH-225A FWH-250A <sup>*1</sup>
2006	FWH-45B	2110	FWH-225A FWH-250A <sup>*1</sup>
2008	FWH-45B	2138	FWH-275A FWH-300A <sup>*1</sup>
2010	FWH-45B	2169	FWH-275A FWH-350A <sup>*1</sup>
2012	FWH-50B	2211	FWH-325A FWH-450A <sup>*1</sup>
2018	FWH-80B	2257	FWH-600A
2021	FWH-80B	2313	FWH-800A
2030	FWH-125B	2360	FWH-1000B
2042	FWH-150B	2415	FWH-1000B
2056	FWH-200B		
2070	FWH-225A		

\*1 Yaskawa recommends a fuse with a large rated current for applications with repeated loads.

### Three-Phase 400 V Class

**Table 13.4 Factory-Recommended Branch Circuit Protection (400 V Class)**

Drive Model	Semiconductor Protection Fuse Model Manufacturer: EATON/Bussmann	Drive Model	Semiconductor Protection Fuse Model Manufacturer: EATON/Bussmann
4002	FWH-50B	4103	FWH-275A
4004	FWH-50B	4140	FWH-300A
4005	FWH-50B	4168	FWH-325A FWH-400A <sup>*1</sup>
4007	FWH-60B	4208	FWH-500A
4009	FWH-60B	4250	FWH-600A
4012	FWH-60B	4302	FWH-700A
4018	FWH-80B	4371	FWH-800A
4023	FWH-90B	4414	FWH-1000B
4031	FWH-150B	4477	FWH-1200B
4038	FWH-200B	4568	FWH-1200B
4044	FWH-200B	4605	FWH-1400A FWH-1600A <sup>*1</sup>
4060	FWH-225A	4720	FWH-1400A FWH-1600A <sup>*1</sup>
4075	FWH-250A		
4089	FWH-275A		

\*1 Yaskawa recommends a fuse with a large rated current for applications with repeated loads.

### ■ CE Standards Compliance for DC Power Supply Input

To comply with CE Standards, install a fuse for the DC power supply input.

Figure 13.3 shows a wiring example for a DC power supply that has two drives connected in parallel.

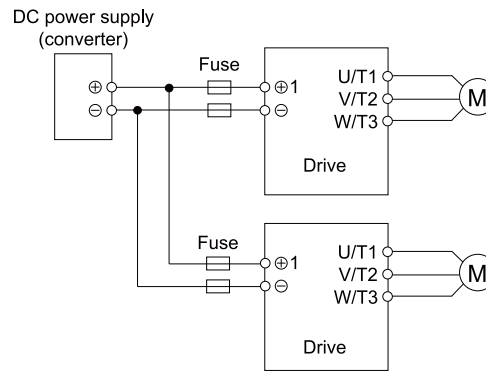

**Figure 13.3 Wiring Example for DC Power Supply Input**

**⚠ WARNING** *Electrical Shock Hazard. Do not ground the main circuit bus. Incorrect wiring can cause serious injury or death.*

**Note:**

- Install a fuse for each drive when operating more than one drive. If one fuse blows, replace all fuses.
- Install the external filter (system) to comply with the EMC Directive.

Refer to [Table 13.5](#) and [Table 13.6](#) for the recommended fuses.

**Table 13.5 Recommended Fuse (Three-Phase 200 V Class)**

Drive Model	Fuse Manufacturer: Bussmann		Drive Model	Fuse Manufacturer: Bussmann	
	Model	Qty		Model	Qty
2004	FWH-45B	2	2110	FWH-250A FWH-275A <i>*1</i>	2
2006	FWH-45B	2	2138	FWH-300A FWH-350A <i>*1</i>	2
2008	FWH-45B	2	2169	FWH-350A FWH-450A <i>*1</i>	2
2010	FWH-45B	2	2211	FWH-450A FWH-600A <i>*1</i>	2
2012	FWH-50B	2	2257	FWH-600A FWH-700A <i>*1</i>	2
2018	FWH-80B	2	2313	FWH-800A FWH-1000B <i>*1</i>	2
2021	FWH-80B	2	2360	FWH-1000B	2
2030	FWH-125B	2	2415	FWH-1000B	2
2042	FWH-150B	2			
2056	FWH-200B	2			
2070	FWH-250A	2			
2082	FWH-250A FWH-300A <i>*1</i>	2			

\*1 Yaskawa recommends a fuse with a large rated current for applications with repeated loads.

**Table 13.6 Recommended Fuse (Three-Phase 400 V Class)**

Drive Model	Fuse Manufacturer: Bussmann		Drive Model	Fuse Manufacturer: Bussmann	
	Model	Qty		Model	Qty
4002	FWH-50B	2	4031	FWH-150B	2
4004	FWH-50B	2	4038	FWH-200B	2
4005	FWH-50B	2	4044	FWH-200B	2
4007	FWH-60B	2	4060	FWH-225A	2
4009	FWH-60B	2	4075	FWH-250A	2
4012	FWH-60B	2	4089	FWH-275A	2
4018	FWH-80B	2	4103	FWH-275A	2
4023	FWH-90B	2			

Drive Model	Fuse Manufacturer: Bussmann	
	Model	Qty
4140	FWH-300A FWH-325A <i>*1</i>	2
4168	FWH-400A FWH-450A <i>*1</i>	2
4208	FWH-500A FWH-600A <i>*1</i>	2
4250	FWH-600A FWH-700A <i>*1</i>	2
4302	FWH-700A FWH-800A <i>*1</i>	2

Drive Model	Fuse Manufacturer: Bussmann	
	Model	Qty
4371	FWH-800A FWH-1000B <i>*1</i>	2
4414	FWH-1000B FWH-1200B <i>*1</i>	2
4477	FWH-1200B FWH-1400A <i>*1</i>	2
4568	FWH-1200B FWH-1600A <i>*1</i>	2
4605	FWH-1600A	2
4720	FWH-1600A	2

\*1 Yaskawa recommends a fuse with a large rated current for applications with repeated loads.

## 14 China RoHS Compliance



Figure 14.1 China RoHS Mark

The China RoHS mark is displayed on products containing six specified hazardous substances that are in excess of regulatory limits, based on the “Administrative Measures for the Restriction of the Use of Hazardous Substances in Electrical and Electronic Products” and “Marking for the Restricted Use of Hazardous Substances in Electronic and Electrical Products” (SJ/T 11364-2014), which were promulgated on January 26, 2016. The number displayed in the center of the mark indicates the environment-friendly use period (number of years) in which electrical and electronic products that are being produced, sold, or imported to China can be used. The date of manufacture of the electrical and electronic product is the starting date of the environment-friendly use period for the product. The six specified hazardous substances contained in the product will not leak outside of the product during normal use within this period and will have no serious impact on the environment, the human body, or property.

The environment-friendly use period for this product is 15 years. This period is not the product warranty period.

### ◆ Information on Hazardous Substances in This Product

Table 14.1 shows the details on hazardous substances contained in this product.

Table 14.1 Contents of Hazardous Substances in This Product

Parts Name	Hazardous Substances					
	Lead (Pb)	Mercury (Hg)	Cadmium (Cd)	Hexavalent Chromium (Cr(VI))	Polybrominated Biphenyls (PBB)	Polybrominated Diphenyl Ethers (PBDE)
Circuit Board	×	○	○	○	○	○
Electronic Parts	×	○	○	○	○	○
Brass Screw	×	○	○	○	○	○
Aluminum Die Casting	×	○	○	○	○	○

This table has been prepared in accordance with the provisions outlined in SJ/T 11364.  
 ○: Indicates that said hazardous substance contained in all of the homogeneous materials for this part is below or equal to the limit requirement of GB/T 26572.  
 ×: Indicates that said hazardous substance contained in at least one of the homogeneous materials used for this part is above the limit requirement of GB/T 26572.

**Note:**  
 This product complies with EU RoHS directives. In this table, "×" indicates that hazardous substances that are exempt from EU RoHS directives are contained.

## 15 对应中国RoHS指令



图 15.1 中国RoHS标志

中国RoHS标志依据2016年1月26日公布的《电器电子产品有害物质限制使用管理办法》，以及《电子电气产品有害物质限制使用标识要求》（SJ/T 11364-2014）作成。电子电气产品中特定6种有害物质的含量超过规定值时，应标识此标志。中间的数字为在中国生产销售以及进口的电子电气产品的环保使用期限（年限）。电子电气产品的环保使用期限从生产日期算起。在期限内，正常使用产品的过程中，不会有特定的6种有害物质外泄进而对环境、人和财产造成深刻影响。

本产品的环保使用期限为15年。但需要注意的是环保使用期限并非产品的质量保证期限。

## ◆ 本产品中含有有害物质的信息

本产品中所含有害物质的详细信息如表 15.1 所示。

表 15.1 本产品中有害物质的名称及含量

部件名称	有害物质					
	铅 (Pb)	汞 (Hg)	镉 (Cd)	六价铬 (Cr(VI))	多溴联苯 (PBB)	多溴二苯醚 (PBDE)
实装基板	×	○	○	○	○	○
电子元件	×	○	○	○	○	○
黄铜螺钉	×	○	○	○	○	○
铝压铸	×	○	○	○	○	○

本表格依据SJ/T 11364的规定编制。  
 ○:表示该有害物质在该部件所有均质材料中的含量均在GB/T 26572规定的限量要求以下。  
 ×:表示该有害物质至少在该部件的某一均质材料中的含量超出GB/T 26572规定的限量要求。  
 (注) 本产品符合欧盟RoHS指令。上表中的“×”表示含有欧盟RoHS指令豁免的有害物质。

## 16 Safe Disable Input

This section gives precautions to support the Safe Disable input. Contact Yaskawa for more information.

The safety function complies with the standards shown in Table 16.1.

Table 16.1 Applied Safety Standards and Unified Standards

Safety Standards	Unified Standards
Functional Safety	IEC/EN 61508 (SIL3)
	IEC/EN 62061 (SILCL3)
	IEC/EN 61800-5-2 (SIL3)
Machine Safety	ISO/EN ISO 13849-1:2015 (Cat.3, PL e)
EMC	IEC/EN 61000-6-7

### Note:

- SIL = Safety Integrity Level.
- SILCL = SIL Claim Limit.

## ◆ Safe Disable Specifications

The Safe Disable input provides the stop function that complies with “Safe Torque Off” as specified by IEC/EN 61800-5-2:2007. The Safe Disable input meets the requirements of EN ISO 13849-1 and IEC/EN 61508. It also has a safety status monitor to detect safety circuit errors.

When you install the drive as a component in a system, you must make sure that the system complies with the applicable safety standards.

Refer to Table 16.2 for safety function specifications.

Table 16.2 Safe Disable Specifications

Item	Description
Input/Output	<ul style="list-style-type: none"> <li>• Input: 2 Safe Disable input (H1, H2) Signal ON level: 18 Vdc to 28 Vdc Signal OFF level: -4 Vdc to +4 Vdc</li> <li>• Output: 1 MFDO safety monitor output for external device monitor (EDM)</li> </ul>
Response time from when the input opens to when the drive output stops	3 ms or less
Response time from when the H1 and H2 terminal inputs open to when the EDM signal operates	20 ms or less

Item		Description
Failure probability	Less frequent operation request mode	PFD = 4.65E <sup>-6</sup>
	Frequent operation request mode or continuous mode	PFH = 1.11E <sup>-9</sup>
Performance level		The Safe Disable input complies with the performance level requirements of EN ISO 13849-1.
HFT (hardware fault tolerance)		N = 1
Type of subsystem		Type B

**Note:**

EDM = External Device Monitoring

PFD = Probability of Failure on Demand

PFH = Probability of Dangerous Failure per Hour

## ◆ Notes

**⚠ DANGER** Sudden Movement Hazard. When you use the Safe Disable function in the safety system of a machine, do a full risk assessment for the system to make sure that all parts of the system comply with applicable safety standards. Incorrect application of the Safe Disable function can cause serious injury or death.

**⚠ DANGER** Sudden Movement Hazard. If the output circuit of the drive is damaged and the Safe Disable function turns OFF the drive output to a permanent magnet (PM) motor, the motor can rotate 180 electrical degrees. Prevent damage to equipment and injury to personnel during this condition. Sudden motor movement can cause serious injury or death. It is possible for current to flow through the motor winding in these conditions.

**⚠ DANGER** Electrical Shock Hazard. You cannot depend on the Safe Disable function to prevent electrical shock. Disconnect all power to the drive and wait for the time specified on the warning label before you remove covers. Check the drive for dangerous voltages before servicing or repair work. If you do work on the drive when it is energized and there is no cover over the electronic circuits, it can cause serious injury or death.

**⚠ WARNING** Sudden Movement Hazard. Although the Safe Disable function is in operation, gravity or other external forces in the vertical axis can move the motor. Incorrect application of the Safe Disable function can cause serious injury or death.

**⚠ WARNING** Sudden Movement Hazard. Do not use the drive output signals to control external holding brakes or dynamic brakes for functional safety. Use a system that conforms to the functional safety requirements. Incorrect application of the Safe Disable function can cause serious injury or death. Systems that use drive output signals (including EDM) for safety are not safe because drive output signals are not safety components.

**⚠ WARNING** Sudden Movement Hazard. Connect the Safe Disable inputs to the devices as specified by the safety requirements. If you connect the Safe Disable inputs incorrectly, it can cause serious injury or death.

**⚠ WARNING** Sudden Movement Hazard. To use the Safe Disable inputs, remove the jumpers between terminals H1-HC and H2-HC. If the Safe Disable circuit does not work correctly, it can cause serious injury or death.

**⚠ WARNING** Sudden Movement Hazard. When you clear the Safe Disable input, make sure that the Safe Disable Monitor output operates correctly as the specification for Safe Disable function. If the Safe Disable circuit does not operate correctly, it can cause serious injury or death.

**⚠ WARNING** Sudden Movement Hazard. Regularly examine the Safe Disable input and all other safety features. A system that does not operate correctly can cause serious injury or death.

**⚠ WARNING** Sudden Movement Hazard. Only let approved personnel who know about the drive, instruction manual, and safety standards wire, examine, and maintain the Safe Disable input. If personnel are not approved, it can cause serious injury or death.

**⚠ WARNING** Sudden Movement Hazard. Only use the Safe Disable Monitor (multi-function output terminal set to the EDM function) to monitor the Safe Disable status or to find a malfunction in the Safe Disable inputs. The monitor output is not a safety output. If you use the Safe Disable Monitor incorrectly, it can cause death or serious injury.

**Note:**

- Drives that have a built-in safety function must be replaced 10 years after first use.
- A maximum of 3 ms will elapse from when terminals H1 or H2 shut off until the drive switches to the "Safe Torque Off" status. Set the OFF status for terminals H1 and H2 to hold for at least 3 ms. The drive may not be able to switch to the "Safe Torque Off" status if terminals H1 and H2 are only open for less than 2 ms.

## ◆ Using the Safe Disable Function

### ■ Safe Disable Circuit

The Safe Disable circuit has two isolated channels (terminals H1 and H2) that stop the output transistors. The input can use the internal power supply of the drive.

Set the EDM function to one of the MFDO terminals [ $H2-xx = 21$  or  $121$ ] to monitor the status of the Safe Disable function. This is the “Safe Disable monitor output function”.

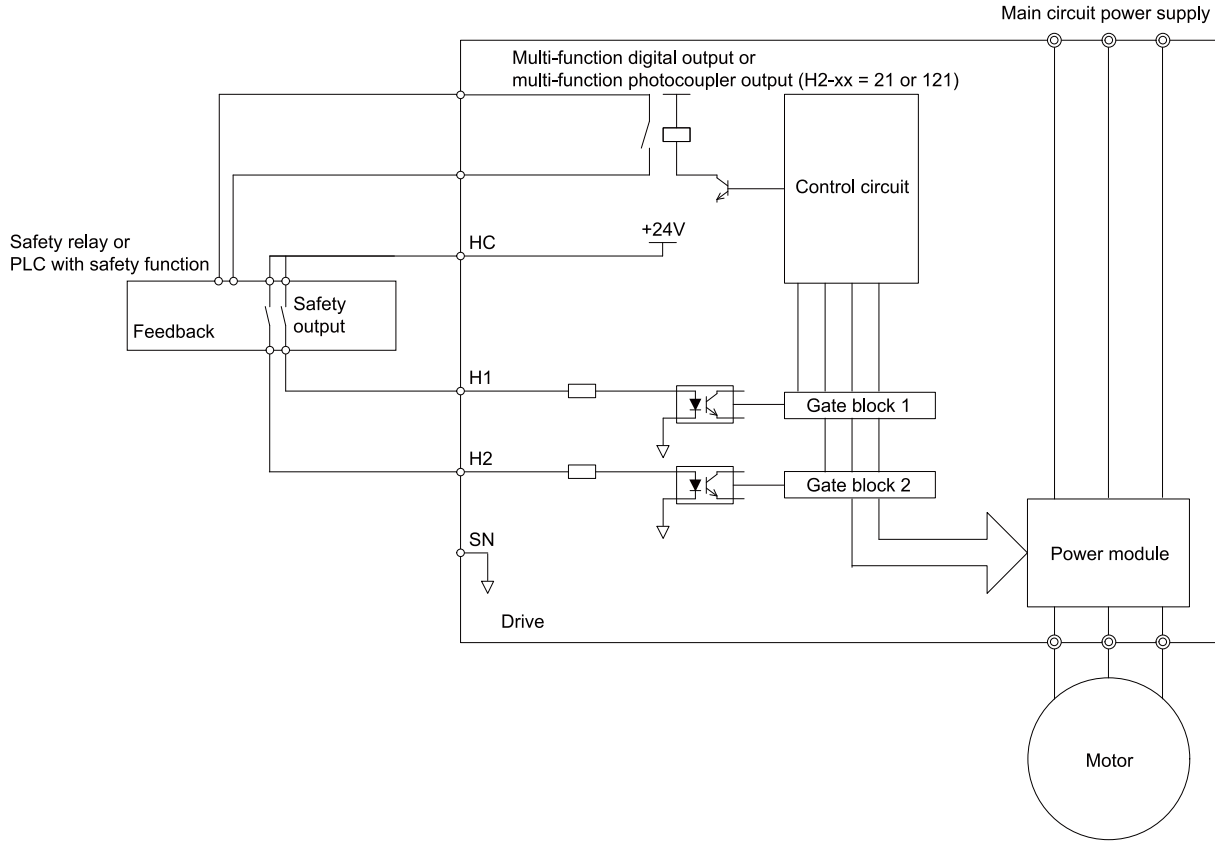

Figure 16.1 Safe Disable Function Wiring Example

### ■ Enabling and Disabling the Drive Output (“Safe Torque Off”)

Refer to Figure 16.2 for an example of drive operation when the drive changes from “Safe Torque Off” status to usual operation.

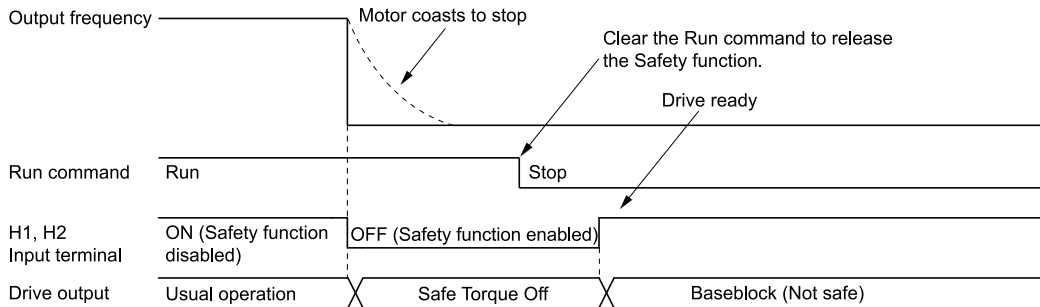

Figure 16.2 Safe Disable Operation

#### Switching from Usual Operation to “Safe Torque Off”

Turn OFF (open) safety input terminal H1 or H2 to enable the Safe Disable function. When the Safe Disable function is enabled while the motor is operating, the drive output and motor torque turn off and the motor always coasts to stop. The *b1-03 [Stopping Method Selection]* setting does not have an effect on the stopping method.



The “Safe Torque Off” status is only possible with the Safe Disable function. Clear the Run command to stop the drive. Turning off drive output (a baseblock condition) ≠ “Safe Torque Off”.

**Note:**

- When it is necessary to ramp to stop the motor, do not turn off terminals H1 and H2 until the motor fully stops. This will prevent the motor from coasting to stop during usual operation.
- A maximum of 3 ms will elapse from when terminals H1 or H2 shut off until the drive switches to the “Safe Torque Off” status. Set the OFF status for terminals H1 and H2 to hold for at least 2 ms. The drive may not be able to switch to the “Safe Torque Off” status if terminals H1 and H2 are only open for less than 2 ms.

### Going from “Safe Torque Off” to Usual Operation

The safety input will only release when there is no Run command.

- **During Stop**  
When the Safe Disable function is triggered during stop, close the circuit between terminals H1-HC and H2-HC to disable “Safe Torque Off”. Enter the Run command after the drive stops correctly.
- **During Run**  
When the Safe Disable function is triggered during run, close the circuit between terminals H1-HC and H2-HC to disable “Safe Torque Off” after clearing the Run command. Enter the Stop command, then enter the Run command when terminals H1 and H2 are ON or OFF.

## ■ Safe Disable Monitor Output Function and Keypad Display

Refer to [Table 16.3](#) for information about the relation between the input channel status, Safety monitor output status, and drive output status.

**Table 16.3 Safe Disable Input and External Device Monitor (EDM) Terminal Status**

Input Channel Status	Input 1 (H1-HC)	ON (Close the circuit)	OFF (Open)	ON (Close the circuit)	OFF (Open)
	Input 2 (H2-HC)	ON (Close the circuit)	ON (Close the circuit)	OFF (Open)	OFF (Open)
MFDO Terminal (H2-xx = 21)	MFDO Terminal (H2-xx = 21)	OFF	OFF	OFF	ON
	MFDO Terminal (H2-xx = 121)	ON	ON	ON	OFF
Drive Output Status		Baseblock (Drive ready)	Safety status (STo)	Safety status (STo)	Safety status (STo)
Keypad Display		Normally displayed	SToF (Flashing)	SToF (Flashing)	STo (Flashing)
LED Status Ring		Ready: Illuminated	ALM/ERR: Flashing	ALM/ERR: Flashing	Ready: Flashing
MEMOBUS Register 0020 (Hex.)		bit C: 0 bit D: 0	bit C: 1 bit D: 0	bit C: 1 bit D: 0	bit C: 0 bit D: 1

### Safety Function Status Monitor

The drive Safety monitor output sends a feedback signal about the status of the Safety function. The Safety monitor output is one of the possible settings available for the MFDO terminals. If there is damage to the Safe Disable circuit, a controller (PLC or safety relay) must read this signal as an input signal to hold the “Safe Torque Off” status. This will help verify the condition of the safety circuit. Refer to the manual for the safety device for more information about the Safety function.

You can use the MFDO function settings to switch the polarity of the Safety monitor output signal. Refer to [Table 16.3](#) for setting instructions.

### Keypad Display

If the two input channels are OFF (Open), the keypad will flash *STo* [Safe Torque OFF].

If there is damage to the Safe disable circuit or the drive, the keypad will flash *SToF* [Safe Torque OFF Hardware] when one input channel is OFF (Open) and the other is ON (Close the circuit). When you use the Safe disable circuit correctly, the keypad will not show *SToF*.

If there is damage to the drive, the keypad will show *SCF* [Safety Circuit Fault] when the drive detects a fault in the Safe disable circuit. Refer to the chapter on Troubleshooting for more information.

## ■ Validating the Safe Disable Function

After you replace parts or do maintenance on the drive, first complete all necessary wiring to start the drive, then test the Safe Disable input with these steps. Keep a record of the test results.

**Note:**

This validation should be performed at least once every three months in order to guarantee the specification values of the safety parameters.

1. When the two input channels are OFF (Open), make sure that the keypad flashes *STo* [*Safe Torque OFF*], and make sure that the motor is not running.
2. Monitor the ON/OFF status of the input channels and make sure that MFDO set to the EDM function operates as shown in [Table 16.3](#).

If one or more of these items are true, the ON/OFF status of the MFDO may not display correctly on the keypad:

- Incorrect parameter settings.
- A problem with an external device.
- The external wiring has a short circuit or is disconnected.
- There is damage to the device.

Find the cause and repair the problem to correctly display the status.

3. Make sure that the EDM signal operates during usual operation as shown in [Table 16.3](#).

## 17 Seismic Standards

The Yaskawa drives in this manual are capable of structurally and operationally withstanding the seismic response criteria as defined in the International Building Code (IBC), ASCE7, and California Department of Health Care Access and Information (HCAI).

The models in this manual were tested in compliance with AC-156 to meet the IBC seismic certification as shown on the certification labels.



Figure 17.1 Seismic Certification Label Example for Drives

## 18 Australian Standard



Figure 18.1 Regulatory Compliance Mark

The Regulatory Compliance Mark (RCM) identifies that the product meets the requirements of the related ACMA Standards in the Radiocommunications Act of 1992 and the Telecommunications Act of 1997.

## 19 Disposal Instructions

Correctly discard the drive, packing material, battery, and microSD card as specified by regional, local, and municipal laws and regulations for this product.

**Note:**

- Remove the battery and microSD card from the keypad before you discard the drive.
- You cannot recycle the battery. Discard used batteries as specified by the battery manufacturer.
- Customers are responsible for microSD card data protection.  
PC functions that format and delete the data may not be sufficient to fully erase the microSD card data. Yaskawa recommends that customers physically destroy the microSD card in a shredder or use data wipe software to fully erase the card.

## ◆ WEEE Directive



The wheeled bin symbol on this product, its manual, or its packaging identifies that you must recycle it at the end of its product life.

You must discard the product at an applicable collection point for electrical and electronic equipment (EEE). Do not discard the product with usual waste.

## 20 Maintenance

Refer to the Maintenance & Troubleshooting Manual (TOEPYAIGA8001) for more information.

Only let authorized persons do maintenance, examine, or replace components on the drive.

Read this manual carefully and know all the precautions and safety information before installing, wiring, repairing, or examining the drive or replacing components.

Examine and maintain the drive and peripheral devices regularly to extend the life of the drive and decrease performance deterioration, decrease early wear, and decrease drive failures.

Regular examinations and maintenance will also decrease system downtime.

Refer to the Technical Reference (SIEPC71061737) for more information about maintenance and examinations.

Examine the drive one time each year at a minimum.

The operating conditions, environmental conditions, and use conditions will have an effect on the examination frequency for connected equipment.

Examine the drive more frequently if you use the drive in bad conditions or in these conditions:

- High ambient temperatures
- Frequent starting and stopping
- Changes in the AC power supply or load
- Too much vibration or shock loading
- Dust, metal dust, salt, sulfuric acid, or chlorine atmospheres
- Unsatisfactory storage conditions.

The drive has Maintenance Monitors that keep track of component wear and warn maintenance period when the estimated performance life is approaching. This Maintenance Monitor eliminates the need to shut down the entire system for unexpected problems.



Users can set alarm notifications to inform the maintenance periods for a specific drive component.

## 21 Troubleshooting



Refer to the Maintenance & Troubleshooting Manual (TOEPYAIGA8001) for more information.

If the drive or motor do not operate correctly, look at the drive keypad for fault and alarm information.

- For drive faults:

- The keypad shows the fault code.
-  and ALM/ERR on the LED Status Ring illuminate continuously.
- The drive shuts off output and the fault relay output activates. The motor coasts to stop.
- For drive alarms:
  - The keypad shows the alarm code.
  -  and ALM/ERR on the LED Status Ring flash.
  - Usually, the drive will continue to operate the motor. Some alarms let you select a motor stopping method.

### ◆ Fault Reset

1. Remove the cause of the fault or alarm.
2. While the keypad is showing the fault or alarm code, push  (RESET) or  on the keypad.

### ◆ Fault

This section gives information about some of the causes and possible solutions of faults. You must use the Fault Reset operation to remove the fault before you can operate the drive. Use the information in this table to remove the cause of the fault.

Code	Name	Causes	Possible Solutions
bAT	Keypad Battery Low Voltage	The keypad battery voltage is low.	Replace the keypad battery.
bCE	Bluetooth Communication Fault	The smartphone or tablet with DriveWizard Mobile installed is too far from the keypad.	Use the smartphone or tablet 10 m (32.8 ft) or nearer to the keypad. <b>Note:</b> <i>bCE</i> can occur when the smartphone or tablet is 10 m (32.8 ft) or nearer to the keypad depending on the specifications of the smartphone or tablet.
		Radio waves from a different device are causing interference with communications between the smartphone or tablet and keypad.	Make sure that no device around the keypad uses the same radio bandwidth (2400 MHz to 2480 MHz), and prevent radio interference.
boL	BrakingTransistor Overload Fault	The duty cycle of the braking transistor is high (the regeneration power or repetition frequency is high).	<ul style="list-style-type: none"> <li>• Install a braking unit (CDBR-series).</li> <li>• Install a regenerative converter.</li> <li>• Increase the deceleration time.</li> </ul>
bUS	Option Communication Error	The drive did not receive a signal from the controller.	Correct wiring errors.
CE	Modbus Communication Error	The communications cable wiring is incorrect.	Correct wiring errors.
		There is a short circuit in the communications cable or the communications cable is not connected.	<ul style="list-style-type: none"> <li>• Repair short circuits and connect cables.</li> <li>• Replace the defective communications cable.</li> </ul>
		Electrical interference caused a communication data error.	<ul style="list-style-type: none"> <li>• Examine the control circuit lines, main circuit lines, and ground wiring, and decrease the effects of electrical interference.</li> <li>• Make sure that a magnetic contactor is not the source of the electrical interference, then use a Surge Protective Device if necessary.</li> <li>• Use only the recommended cables or other shielded line. Ground the shield on the controller side or the drive input power side.</li> <li>• Separate the communication wiring from drive power lines, and install a noise filter to the input side of the power supply for communication.</li> <li>• Decrease the effects of electrical interference from the controller.</li> </ul>
CF	Control Fault	Motor parameters are set incorrectly	Correctly set the motor parameters and do Auto-Tuning again.
CoF	Current Offset Fault	The drive starts operation while the induced voltage stays in the motor (during coasting to a stop or after fast deceleration).	<ul style="list-style-type: none"> <li>• Make a sequence that does not restart operation when induced voltage stays in the motor.</li> <li>• Set <math>b3-01 = 1</math> [<i>Speed Search at Start Selection = Enabled</i>].</li> <li>• Use <i>Speed Search from Fmax or Fref</i> [<i>H1-xx = 61, 62</i>] to do a speed search through one of the external terminals.</li> </ul> <p><b>Note:</b> When controlling the PM motor, External Speed Search commands 1 and 2 operate the same.</p>

Code	Name	Causes	Possible Solutions
CP1	Comparator 1 Limit Fault	The monitor value set in H2-20 [Comparator 1 Monitor Selection] was in the range of H2-21 [Comparator 1 Lower Limit] and H2-22 [Comparator 1 Upper Limit].	Examine the monitor value and remove the cause of the fault.
CP2	Comparator 2 Limit Fault	The monitor value set in H2-26 [Comparator 2 Monitor Selection] was outside the range of H2-27 [Comparator 2 Lower Limit] and H2-28 [Comparator 2 Upper Limit].	Examine the monitor value and remove the cause of the fault.
CPF00 to CPF03, CPF07 to CPF08, CPF11 to CPF14, CPF16 to CPF24, and CPF26 to CPF39	Control Circuit Error	A drive hardware problem occurred.	<ul style="list-style-type: none"> <li>Re-energize the drive.</li> <li>If the fault stays, replace the control board or the drive. For information about replacing the control board, contact Yaskawa or your nearest sales representative.</li> </ul>
CPF06	Control Circuit Error (EEPROM memory Data Error)	The drive power supply was de-energized while a communication option entered a parameter Write command.	Set A1-03 = 2220, 3330 [Initialize Parameters = 2-Wire Initialization, 3-Wire Initialization] and initialize the drive.
CPF25	Terminal Board not Connected	The terminal board is not correctly connected to the drive.	<ol style="list-style-type: none"> <li>De-energize the drive.</li> <li>Correctly connect the terminal board to the drive.</li> <li>Re-energize the drive.</li> </ol>
dEv	Speed Deviation	The load is too heavy.	Decrease the load.
dv1	Z Pulse Fault	The encoder option card or the encoder on the motor side is damaged.	<ol style="list-style-type: none"> <li>Repair wiring errors and connect disconnected wires. Correctly ground the shielded wire of the encoder cable.</li> <li>Re-energize the drive</li> <li>If the fault stays, replace the control board or the drive. For information about replacing the control board, contact Yaskawa or your nearest sales representative.</li> </ol>
dv2	Z Pulse Noise Fault Detection	Noise interference along the encoder cable.	Isolate the encoder cable from the drive output line or a different source of electrical interference.
dv3	Inversion Detection	E5-11 [Encoder Z-Pulse Offset] is set incorrectly.	Correctly set the value for $\Delta\theta$ to E5-11 as specified by the values on the motor nameplate.
dv4	Inversion Prevention Detection	An external force on the load side rotated the motor.	<ul style="list-style-type: none"> <li>Make sure that the motor is rotating in the correct direction.</li> <li>Find and repair problems on the load side that cause the motor to rotate from the load side.</li> <li>Disable detection of this fault for applications that rotate the motor from the load side in the opposite direction of the speed reference. The drive will not detect this fault if F1-19 = 0 [Deviation 4 Detection Selection = Disabled].</li> </ul>
		E5-11 [Encoder Z-Pulse Offset] is set incorrectly.	Correctly set the value for $\Delta\theta$ to E5-11 as specified by the values on the motor nameplate.
		There is a new encoder or the motor rotation direction changed.	Do Z Pulse Offset Tuning.
		Noise interference along the encoder cable.	Correctly ground the shielded wire of the encoder cable.
		The encoder cable is disconnected or wired incorrectly.	Examine for wiring errors or disconnected wires in the encoder cable, and repair problems.
		The drive incorrectly detected the motor magnetic pole position.	If the value for U6-57 [PolePolarityDeterVal] is lower than 819, increase the value set in n8-84 [Polarity Detection Current]. Consult the motor manufacturer for information about maximum setting values.
		The setting of n8-84 [Polarity Detection Current] is too low.	Increase the n8-84 setting from the default. Consult the motor manufacturer for information about maximum setting values.
		Pole Position Detection failed.	If you are using an IPM motor, do High Frequency Injection Auto-Tuning.
	The PG option card or the encoder on the motor side is damaged.	Repair the wiring and re-energize the drive, then replace the PG option card or the PG if the problem continues.	
dv7	Polarity Judge Timeout	There is a disconnection in the motor coil winding.	Measure the motor line-to-line resistance and replace the motor if a coil is disconnected.
dWF1	EEPROM Memory DWEZ Data Error	There is an error in the EEPROM peripheral circuit.	<ul style="list-style-type: none"> <li>Re-energize the drive.</li> <li>If the fault stays, replace the control board or the drive. For information about replacing the control board, contact Yaskawa or your nearest sales representative.</li> </ul>
dWFL	DriveWorksEZ Fault	There was a fault in the DriveWorksEZ program.	Examine the DriveWorksEZ program and remove the cause of the fault. This is not a drive fault.

## 21 Troubleshooting

Code	Name	Causes	Possible Solutions
E5	MECHATROLINK Watchdog Timer Err	The drive detected a watchdog circuit exception while it received data from the controller.	Examine the MECHATROLINK cable connection. If this error occurs frequently, examine the wiring and decrease the effects of electrical interference as specified by these manuals: <ul style="list-style-type: none"> <li>MECHATROLINK-II Installation Guide (MECHATROLINK Members Association, manual number MMATDEP011)</li> <li>MECHATROLINK-III Installation Manual (MECHATROLINK Members Association, publication number MMATDEP018)</li> </ul>
EF0	Option Card External Fault	The communication option received an external fault from the controller.	<ol style="list-style-type: none"> <li>Find the device that caused the external fault and remove the cause.</li> <li>Clear the external fault input from the controller.</li> </ol>
EF1	External Fault (Terminal S1)	MFDI terminal S1 caused an external fault through an external device.	<ol style="list-style-type: none"> <li>Find the device that caused the external fault and remove the cause.</li> <li>Clear the external fault input in the MFDI.</li> </ol>
EF2	External Fault (Terminal S2)	MFDI terminal S2 caused an external fault through an external device.	<ol style="list-style-type: none"> <li>Find the device that caused the external fault and remove the cause.</li> <li>Clear the external fault input in the MFDI.</li> </ol>
EF3	External Fault (Terminal S3)	MFDI terminal S3 caused an external fault through an external device.	<ol style="list-style-type: none"> <li>Find the device that caused the external fault and remove the cause.</li> <li>Clear the external fault input in the MFDI.</li> </ol>
EF4	External Fault (Terminal S4)	MFDI terminal S4 caused an external fault through an external device.	<ol style="list-style-type: none"> <li>Find the device that caused the external fault and remove the cause.</li> <li>Clear the external fault input in the MFDI.</li> </ol>
EF5	External Fault (Terminal S5)	MFDI terminal S5 caused an external fault through an external device.	<ol style="list-style-type: none"> <li>Find the device that caused the external fault and remove the cause.</li> <li>Clear the external fault input in the MFDI.</li> </ol>
EF6	External Fault (Terminal S6)	MFDI terminal S6 caused an external fault through an external device.	<ol style="list-style-type: none"> <li>Find the device that caused the external fault and remove the cause.</li> <li>Clear the external fault input in the MFDI.</li> </ol>
EF7	External Fault (Terminal S7)	MFDI terminal S7 caused an external fault through an external device.	<ol style="list-style-type: none"> <li>Find the device that caused the external fault and remove the cause.</li> <li>Clear the external fault input in the MFDI.</li> </ol>
EF8	External Fault (Terminal S8)	MFDI terminal S8 caused an external fault through an external device.	<ol style="list-style-type: none"> <li>Find the device that caused the external fault and remove the cause.</li> <li>Clear the external fault input in the MFDI.</li> </ol>
Err	EEPROM Write Error	There was a problem with the EEPROM hardware.	<ul style="list-style-type: none"> <li>Re-energize the drive.</li> <li>If the fault stays, replace the control board or the drive. Contact Yaskawa or your nearest sales representative to replace the board.</li> </ul>
FAn1	Drive Cooling Fan Fault	The cooling fan stopped operating correctly.	<ul style="list-style-type: none"> <li>Examine cooling fan operation.</li> <li>Re-energize the drive.</li> <li>Examine U4-03 [Cooling Fan Ope Time] and U4-04 [Cool Fan Maintenance]. If the performance life of the cooling fan is expired or if there is damage to the fan, replace the fan.</li> </ul>
FbH	Excessive PID Feedback	The <i>FbH</i> detection level is set incorrectly.	Adjust b5-36 [PID High Feedback Detection Lvl] and b5-37 [PID High Feedback Detection Time].
FbL	PID Feedback Loss	The <i>FbL</i> detection level is set incorrectly.	Adjust b5-13 [PID Feedback Loss Detection Lvl] and b5-14 [PID Feedback Loss Detection Time].
GF	Ground Fault	Overheating caused damage to the motor or the motor insulation is not satisfactory.	Measure the motor insulation resistance, and replace the motor if there is electrical conduction or unserviceable insulation.
		The motor main circuit cable is contacting ground to make a short circuit.	<ul style="list-style-type: none"> <li>Examine the motor main circuit cable for damage, and repair short circuits.</li> <li>Measure the resistance between the motor main circuit cable and the ground terminal. If there is electrical conduction, replace the cable.</li> </ul>
		An increase in the stray capacitance of the cable and the ground terminal caused an increase in the leakage current.	<ul style="list-style-type: none"> <li>If the wiring length of the cable is more than 100 m, decrease the carrier frequency.</li> <li>Decrease the stray capacitance.</li> </ul>
		There was a problem with the drive hardware.	Replace the control board or the drive. For information about replacing the control board, contact Yaskawa or your nearest sales representative.
LF	Output Phase Loss	The motor main circuit cable is disconnected.	Connect motor main circuit cable wiring. Correct wiring errors in the main circuit drive input power.
LF2	Output Current Imbalance	Phase loss occurred in the wiring on the output side of the drive.	Examine for wiring errors or disconnected wires on the output side of the drive, and repair problems.

Code	Name	Causes	Possible Solutions
LSo	Low Speed Motor Step-Out	The motor code set incorrectly.	<ul style="list-style-type: none"> <li>Set <i>E5-01 [PM Motor Code Selection]</i> correctly as specified by the motor.</li> <li>For specialized motors, refer to the motor test report and set <i>E5-xx</i> correctly.</li> </ul>
		The load is too large.	<ul style="list-style-type: none"> <li>Decrease the load.</li> <li>Replace the drive and motor with larger capacity models.</li> </ul>
		An external force on the load side caused the motor to move at start.	Find and repair problems on the load side that cause the motor to rotate from the load side.
		The drive incorrectly detected the motor magnetic pole position.	<ul style="list-style-type: none"> <li>Set <i>b3-01 = 1 [Speed Search at Start Selection = Enabled]</i>.</li> <li>If the value for <i>U6-57 [PolePolarityDeterVal]</i> is lower than 819, increase the value set in <i>n8-84 [Polarity Detection Current]</i>. Consult the motor manufacturer for information about maximum setting values.</li> </ul>
		The setting of <i>n8-84 [Polarity Detection Current]</i> is too low.	Increase the n8-84 setting from the default. Consult the motor manufacturer for information about maximum setting values.
		Incorrect values set in <i>L8-93 [Low Speed Pull-out DetectionTime]</i> , <i>L8-94 [Low Speed Pull-out Detect Level]</i> , and <i>L8-95 [Low Speed Pull-out Amount]</i> .	Increase the values set in <i>L8-93</i> to <i>L8-95</i> .
		The drive incorrectly detected the motor magnetic pole position.	If you are using an IPM motor, do High Frequency Injection Auto-Tuning.
nSE	Node Setup Error	The <i>H1-xx = 47 [Node Setup (CANopen)]</i> terminal was activated during run.	Stop the drive when the Node Setup function is in use.
oC	Overcurrent	The load is too heavy.	<ul style="list-style-type: none"> <li>Measure the current flowing into the motor.</li> <li>Replace the drive with a larger capacity model if the current value is more than the drive rated current.</li> <li>Decrease the load or replace with a larger drive to prevent sudden changes in the current level.</li> </ul>
		Overheating caused damage to the motor or the motor insulation is not satisfactory.	Measure the motor insulation resistance, and replace the motor if there is electrical conduction or unserviceable insulation.
		The motor main circuit cable is contacting ground to make a short circuit.	<ul style="list-style-type: none"> <li>Examine the motor main circuit cable for damage, and repair short circuits.</li> <li>Measure the resistance between the motor main circuit cable and the ground terminal. If there is electrical conduction, replace the cable.</li> </ul>
		A short circuit or ground fault on the drive output side caused damage to the output transistor of the drive.	<ul style="list-style-type: none"> <li>Make sure that there is not a short circuit in terminal B1 and terminals U/T1, V/T2, and W/T3. Make sure that there is not a short circuit in terminals - and terminals U/T1, V/T2, and W/T3.</li> <li>If there is a short circuit, contact Yaskawa or your nearest sales representative.</li> </ul>
		The acceleration time is too short.	<ul style="list-style-type: none"> <li>Calculate the torque necessary during acceleration related to the load inertia and the specified acceleration time.</li> <li>Increase the values set in <i>C1-01</i>, <i>C1-03</i>, <i>C1-05</i>, or <i>C1-07 [Acceleration Times]</i> to get the necessary torque.</li> <li>Increase the values set in <i>C2-01</i> to <i>C2-04 [S-Curve Characteristics]</i> to get the necessary torque.</li> <li>Replace the drive with a larger capacity model.</li> </ul>
		The drive is trying to operate a specialized motor or a motor that is larger than the maximum applicable motor output of the drive.	<ul style="list-style-type: none"> <li>Examine the motor nameplate, the motor, and the drive to make sure that the drive rated current is larger than the motor rated current.</li> <li>Replace the drive with a larger capacity model.</li> </ul>
		A magnetic contactor was switched at the output.	Set the operation sequence to not turn ON or OFF the magnetic contactor while the drive is outputting voltage.
		The V/f pattern settings are incorrect.	<ul style="list-style-type: none"> <li>Examine the ratios between the V/f pattern frequency and voltage. Decrease the voltage if it is too high compared to the frequency.</li> <li>Adjust <i>E1-04</i> to <i>E1-10 [V/f Pattern Parameters]</i>. For motor 2, adjust <i>E3-04</i> to <i>E3-10</i>.</li> </ul>
		The torque compensation gain is too large.	Decrease the value set in <i>C4-01 [Torque Compensation Gain]</i> to make sure that the motor does not stall.
		Electrical interference caused a problem.	Examine the control circuit lines, main circuit lines, and ground wiring, and decrease the effects of electrical interference.
		The gain during overexcitation operation is too large.	<ul style="list-style-type: none"> <li>Find the time when the fault occurs.</li> <li>If the fault occurs at the same time as overexcitation operation, decrease the value set in <i>n3-13 [OverexcitationBraking (OEB) Gain]</i> and consider the motor flux saturation.</li> </ul>

Code	Name	Causes	Possible Solutions
		The drive received a Run command while the motor was coasting.	<ul style="list-style-type: none"> <li>Examine the sequence and input the Run command after the motor fully stops.</li> <li>Set <math>b3-01 = 1</math> [<i>Speed Search at Start Selection = Enabled</i>] or set <math>H1-xx = 61, 62</math> [<i>Speed Search from Fmax or Fref</i>] to input speed search commands from the MFDI terminals.</li> </ul>
		In PM Control Methods, the setting of the motor code is incorrect.	<ul style="list-style-type: none"> <li>Enter the correct motor code to <math>E5-01</math> [<i>PM Motor Code Selection</i>] as specified by the PM motor.</li> <li>For specialized motors, refer to the motor test report and set <math>E5-xx</math> [<i>PM Motor Settings</i>] correctly.</li> </ul>
		If the drive detects the fault at start or in the low speed range (10% or less) and $n8-57 = 1$ [ <i>HFI Overlap Selection = Enabled</i> ] for PM Control methods, the high frequency injection gain is too high.	<ul style="list-style-type: none"> <li>Set <math>E5-xx</math> [<i>PM Motor Parameters</i>] correctly or do Rotational Auto-Tuning.</li> <li>Decrease the value of <math>n8-41</math> [<i>HFI P Gain</i>] in 0.5-unit increments.</li> </ul> <p><b>Note:</b> Set <math>n8-41 &gt; 0.0</math> for IPM motors.</p>
		The current flowing in the motor is more than the value set in $L8-27$ [ <i>Overcurrent Detection Gain</i> ] for PM Control Methods.	Correct the value set in $L8-27$ .
		The control method is set incorrectly for the motor.	Set $A1-02$ [ <i>Control Method Selection</i> ] correctly.
		The motor main circuit cable is too long.	Replace the drive with a larger capacity model.
		Speed search does not complete at start when you set $A1-02 = 8$ [ <i>EZ Vector Control</i> ] and use an induction motor.	When $E9-01 = 0$ [ <i>Motor Type Selection = Induction (IM)</i> ], set $b3-24 = 2$ [ <i>Speed Search Method Selection = Current Detection Speed Search</i> ].
		An overcurrent occurred during overexcitation deceleration.	<ul style="list-style-type: none"> <li>Decrease the value set in <math>n3-13</math> [<i>OverexcitationBraking (OEB) Gain</i>].</li> <li>Decrease the value set in <math>n3-21</math> [<i>HSB Current Suppression Level</i>].</li> </ul>
		When you use an IE3 premium efficiency motor.	Use these values to adjust the parameters. <ul style="list-style-type: none"> <li><math>b3-03</math> [<i>Speed Search Deceleration Time</i>] = default value <math>\times 2</math></li> <li><math>L2-03</math> [<i>Minimum Baseblock Time</i>] = default value <math>\times 2</math></li> <li><math>L2-04</math> [<i>Powerloss V/f Recovery Ramp Time</i>] = default value <math>\times 2</math></li> </ul>
oFA00	Option Not Compatible with Port	The option connected to connector CN5-A is not compatible.	Connect the option to the correct connector. <b>Note:</b> Encoder options are not compatible with connector CN5-A.
oFA01	Option Fault/Connection Error	The option card connected to connector CN5-A is not compatible.	<ol style="list-style-type: none"> <li>De-energize the drive.</li> <li>Refer to the option card manual and correctly connect the option card to the connector on the drive.</li> </ol>
oFA02	Duplicate Options	The same option cards or the same type of option cards are connected to connectors CN5-A, B, and C.	Connect the option card to the correct connector. <b>Note:</b> Use connectors CN5-C and CN5-B to connect two encoder option cards.
oFA03 to oFA06	Option Card Error Occurred at Option Port CN5-A	A fault occurred in the option card.	<ol style="list-style-type: none"> <li>De-energize the drive.</li> <li>Make sure that the option card is correctly connected to the connector.</li> <li>If the problem continues, replace the option card.</li> </ol>
oFA10, oFA11	Option Card Error Occurred at Option Port CN5-A	A fault occurred in the option card.	<ol style="list-style-type: none"> <li>De-energize the drive.</li> <li>Make sure that the option card is correctly connected to the connector.</li> <li>If the problem continues, replace the option card.</li> </ol>
oFA12 to oFA17	Option Card Connection Error (CN5-A)	A fault occurred in the option card.	<ol style="list-style-type: none"> <li>De-energize the drive.</li> <li>Make sure that the option card is correctly connected to the connector.</li> <li>If the problem continues, replace the option card.</li> </ol>
oFA30 to oFA43	Communication Option Card Connection Error (CN5-A)	A fault occurred in the option card.	<ol style="list-style-type: none"> <li>De-energize the drive.</li> <li>Make sure that the option card is correctly connected to the connector.</li> <li>If the problem continues, replace the option card.</li> </ol>
oFb00	Option Not Compatible with Port	The option connected to connector CN5-B is not compatible.	Connect the option to the correct connector. <b>Note:</b> DO-A3, AO-A3, PG-B3, and PG-X3 options can connect to connector CN5-B. To connect only one PG option card, use the CN5-C connector.
oFb01	Option Fault/Connection Error	The option card connected to connector CN5-B was changed during operation.	<ol style="list-style-type: none"> <li>De-energize the drive.</li> <li>Refer to the option card manual and correctly connect the option card to the connector on the drive.</li> </ol>



Code	Name	Causes	Possible Solutions
oFb02	Duplicate Options	The same option cards or the same type of option cards are connected to connectors CN5-A, B, and C.	Connect the option card to the correct connector.
oFb03 to oFb11	Option Card Error Occurred at Option Port CN5-B	A fault occurred in the option card.	<ol style="list-style-type: none"> <li>1. De-energize the drive.</li> <li>2. Make sure that the option card is correctly connected to the connector.</li> <li>3. If the problem continues, replace the option card.</li> </ol>
oFb12 to oFb17	Option Card Error Occurred at Option Port CN5-B	A fault occurred in the option card.	<ol style="list-style-type: none"> <li>1. De-energize the drive.</li> <li>2. Make sure that the option card is correctly connected to the connector.</li> <li>3. If the problem continues, replace the option card.</li> </ol>
oFC00	Option Not Compatible with Port	The option connected to connector CN5-C is not compatible.	<p>Connect the option to the correct connector.</p> <p><b>Note:</b> AI-A3, DI-A3, and communication options cannot be connected to the CN5-C connector.</p>
oFC01	Option Fault/Connection Error	The option card connected to connector CN5-C was changed during operation.	<ol style="list-style-type: none"> <li>1. De-energize the drive.</li> <li>2. Refer to the option card manual and correctly connect the option card to the connector on the drive.</li> </ol>
oFC02	Duplicate Options	The same option cards or the same type of option cards are connected to connectors CN5-A, B, and C.	Connect the option card to the correct connector.
oFC03 to oFC11	Option Card Error Occurred at Option Port CN5-C	A fault occurred in the option card.	<ol style="list-style-type: none"> <li>1. De-energize the drive.</li> <li>2. Make sure that the option card is correctly connected to the connector.</li> <li>3. If the problem continues, replace the option card.</li> </ol>
oFC12 to oFC17	Option Card Error Occurred at Option Port CN5-C	A fault occurred in the option card.	<ol style="list-style-type: none"> <li>1. De-energize the drive.</li> <li>2. Make sure that the option card is correctly connected to the connector.</li> <li>3. If the problem continues, replace the option card.</li> </ol>
oFC50 to oFC55	Option Card Error Occurred at Option Port CN5-C	A fault occurred in the option card.	Refer to the manual for the PG-RT3 or PG-F3 option card.
oH	Heatsink Overheat	The ambient temperature is high and the heatsink temperature of the drive is more than the value set in <i>L8-02 [Overheat Alarm Level]</i> .	<ul style="list-style-type: none"> <li>• Measure the ambient temperature.</li> <li>• Increase the airflow in the control panel.</li> <li>• Install a cooling device (cooling fan or air conditioner) to lower the ambient temperature.</li> <li>• Remove objects near the drive that are producing too much heat.</li> </ul>
oH1	Heatsink Overheat	The ambient temperature is high and the heatsink temperature of the drive is more than the <i>oH1</i> detection level.	<ul style="list-style-type: none"> <li>• Measure the ambient temperature.</li> <li>• Increase the airflow in the control panel.</li> <li>• Install a cooling device (cooling fan or air conditioner) to lower the ambient temperature.</li> <li>• Remove objects near the drive that are producing too much heat.</li> </ul>
oH3	Motor Overheat (PTC Input)	The thermistor wiring that detects motor temperature is defective.	Correct wiring errors.
oH4	Motor Overheat Fault (PTC Input)	The motor has overheated.	<ul style="list-style-type: none"> <li>• Check the load level, acceleration/deceleration time, and motor start/stop frequency (cycle time).</li> <li>• Decrease the load.</li> <li>• Increase the values set in <i>C1-01 to C1-08 [Acceleration/Deceleration Times]</i>.</li> <li>• Set <i>E2-01 [Motor Rated Current (FLA)]</i> correctly to the value specified by the motor nameplate.</li> <li>• Make sure that the motor cooling system is operating correctly, and repair or replace it if it is damaged.</li> <li>• Adjust <i>E1-04 to E1-10 [V/f Pattern Parameters]</i>. For motor 2, adjust <i>E3-04 to E3-10</i>. Decrease the values set in <i>E1-08 [Mid Point A Voltage]</i> and <i>E1-10 [Minimum Output Voltage]</i>.</li> </ul> <p><b>Note:</b> If the values set in <i>E1-08</i> and <i>E1-10</i> are too low, the overload tolerance will decrease at low speeds.</p>
oL1	Motor Overload	The load is too heavy.	<p>Decrease the load.</p> <p><b>Note:</b> Reset <i>oL1</i> when <i>U4-16 [Motor oL1 Level] &lt; 100</i>.</p>
		The acceleration/deceleration times or cycle times are too short.	<ul style="list-style-type: none"> <li>• Examine the acceleration/deceleration times and the motor start/stop frequencies (cycle times).</li> <li>• Increase the values set in <i>C1-01 to C1-08 [Acceleration/Deceleration Times]</i>.</li> </ul>

Code	Name	Causes	Possible Solutions
		Overload occurred while running at low speed.	<ul style="list-style-type: none"> <li>Decrease the load when running at low speed.</li> <li>Increase the motor speed.</li> <li>If the motor is run frequently at low speeds, replace the motor with a larger motor or use a drive-dedicated motor.</li> </ul> <p><b>Note:</b> For general-purpose motors, overload can occur while running at low speed when operating at below the rated current.</p>
		<i>L1-01 [Motor Overload (oL1) Protection]</i> is set incorrectly.	Set <i>L1-01</i> in as specified by the motor qualities for a drive-dedicated motor.
		The V/f pattern does not fit the motor qualities.	<ul style="list-style-type: none"> <li>Examine the ratios between the V/f pattern frequency and voltage. Decrease the voltage if it is too high compared to the frequency.</li> <li>Adjust <i>E1-04</i> to <i>E1-10 [V/f Pattern Parameters]</i>. For motor 2, adjust <i>E3-04</i> to <i>E3-10</i>. Decrease the values set in <i>E1-08 [Mid Point A Voltage]</i> and <i>E1-10 [Minimum Output Voltage]</i>.</li> </ul> <p><b>Note:</b> If the values set in <i>E1-08</i> and <i>E1-10</i> are too low, the overload tolerance will decrease at low speeds.</p>
		<i>E1-06 [Base Frequency]</i> is set incorrectly.	Set <i>E1-06</i> to the rated frequency shown on the motor nameplate.
		One drive is operating more than one motor.	Set <i>L1-01 = 0 [Motor Overload (oL1) Protection = Disabled]</i> , connect thermal overload relay to each motor to prevent damage to the motor.
		The electronic thermal protector qualities and the motor overload properties do not align.	<ul style="list-style-type: none"> <li>Examine the motor qualities and set <i>L1-01 [Motor Overload (oL1) Protection]</i> correctly.</li> <li>Connect a thermal overload relay to the motor.</li> </ul>
		The electronic thermal protector is operating at an incorrect level.	Set <i>E2-01 [Motor Rated Current (FLA)]</i> correctly to the value specified by the motor nameplate.
		There is increased motor loss from overexcitation operation.	<ul style="list-style-type: none"> <li>Lower the value set in <i>n3-13 [OverexcitationBraking (OEB) Gain]</i>.</li> <li>Set <i>L3-04 ≠ 4 [Stall Prevention during Decel ≠ Overexcitation/ High Flux]</i>.</li> <li>Set <i>n3-23 = 0 [Overexcitation Braking Operation = Disabled]</i>.</li> </ul>
		The speed search-related parameters are set incorrectly.	<ul style="list-style-type: none"> <li>Examine the settings for all speed search related parameters.</li> <li>Adjust <i>b3-03 [Speed Search Deceleration Time]</i>.</li> <li>Set <i>b3-24 = 1 [Speed Search Method Selection = Speed Estimation]</i> after Auto-Tuning.</li> </ul>
		Phase loss in the input power supply is causing the output current to change.	Make sure that there is no phase loss, and repair problems.
Overload occurred during overexcitation deceleration.	<ul style="list-style-type: none"> <li>Decrease the value set in <i>n3-13 [OverexcitationBraking (OEB) Gain]</i>.</li> <li>Decrease the value set in <i>n3-21 [HSB Current Suppression Level]</i>.</li> </ul>		
oL2	Drive Overload	The load is too large.	Decrease the load.
		The acceleration/deceleration times or cycle times are too short.	<ul style="list-style-type: none"> <li>Examine the acceleration/deceleration times and the motor start/ stop frequencies (cycle times).</li> <li>Increase the values set in <i>C1-01</i> to <i>C1-08 [Acceleration/ Deceleration Times]</i>.</li> </ul>
		The V/f pattern does not fit the motor qualities.	<ul style="list-style-type: none"> <li>Examine the ratios between the V/f pattern frequency and voltage. Decrease the voltage if it is too high compared to the frequency.</li> <li>Adjust <i>E1-04</i> to <i>E1-10 [V/f Pattern Parameters]</i>. Decrease the values set in <i>E1-08 [Mid Point A Voltage]</i> and <i>E1-10 [Minimum Output Voltage]</i>. For motor 2, adjust <i>E3-04</i> to <i>E3-10</i>.</li> </ul> <p><b>Note:</b> If the values set in <i>E1-08</i> and <i>E1-10</i> are too low, the overload tolerance will decrease at low speeds.</p>
		The drive capacity is too small.	Replace the drive with a larger capacity model.
		Overload occurred while running at low speed.	<ul style="list-style-type: none"> <li>Decrease the load when running at low speed.</li> <li>Replace the drive with a larger capacity model.</li> <li>Decrease the value set in <i>C6-02 [Carrier Frequency Selection]</i>.</li> </ul>
		The torque compensation gain is too large.	Decrease the value set in <i>C4-01 [Torque Compensation Gain]</i> to make sure that the motor does not stall.
		The speed search-related parameters are set incorrectly.	<ul style="list-style-type: none"> <li>Examine the settings for all speed search-related parameters.</li> <li>Adjust <i>b3-03 [Speed Search Deceleration Time]</i>.</li> <li>Set <i>b3-24 = 1 [Speed Search Method Selection = Speed Estimation]</i> after Auto-Tuning.</li> </ul>

Code	Name	Causes	Possible Solutions
		Phase loss in the input power supply is causing the output current to change.	<ul style="list-style-type: none"> <li>Correct errors with the wiring for main circuit drive input power.</li> <li>Make sure that there is no phase loss, and repair problems.</li> </ul>
		Overload occurred during overexcitation deceleration.	<ul style="list-style-type: none"> <li>Decrease the value set in <i>n3-13 [OverexcitationBraking (OEB) Gain]</i>.</li> <li>Decrease the value set in <i>n3-21 [HSB Current Suppression Level]</i>.</li> </ul>
oL3	Overtorque Detection 1	A fault occurred on the machine. Example: The machine is locked.	Examine the machine and remove the cause of the fault.
oL4	Overtorque Detection 2	A fault occurred on the machine. Example: The machine is locked.	Examine the machine and remove the cause of the fault.
oL5	Mechanical Weakening Detection 1	The drive detected overtorque as specified by the conditions for mechanical weakening detection set in <i>L6-08 [Mechanical Fatigue Detect Select]</i> .	Do a deterioration diagnostic test on the machine side.
oL7	High Slip Braking Overload	The load inertia is too large.	<ul style="list-style-type: none"> <li>Decrease deceleration times in <i>C1-02, C1-04, C1-06, and C1-08 [Deceleration Times]</i> for applications that do not use High Slip Braking.</li> <li>Use a braking resistor to decrease the deceleration time.</li> </ul>
oPr	Keypad Connection Fault	The keypad is not securely connected to the connector on the drive.	Examine the connection between the keypad and the drive.
oS	Overspeed	There is overshoot.	<ul style="list-style-type: none"> <li>Decrease <i>C5-01 [ASR Proportional Gain 1]</i> and increase <i>C5-02 [ASR Integral Time 1]</i>.</li> <li>Adjust the pulse train gain with <i>H6-02 to H6-05 [Pulse Train Input Setting Parameters]</i>.</li> </ul>
		There is an incorrect number of PG pulses set in the drive.	Set <i>H6-02 [Terminal RP Frequency Scaling]</i> to the pulse train frequency during 100% reference (maximum motor rotation speed).
		The oS detection level is set incorrectly.	Adjust <i>F1-08 [Overspeed Detection Level]</i> and <i>F1-09 [Overspeed Detection Delay Time]</i> .
		If the drive detects the fault at start or in the low speed range (10% or less) and <i>n8-57 = 1 [HFI Overlap Selection = Enabled]</i> for PM Control methods, the high frequency injection gain is too high.	<ul style="list-style-type: none"> <li>Set <i>E5-xx [PM Motor Parameters]</i> correctly or do Rotational Auto-Tuning.</li> <li>Decrease the value of <i>n8-41 [HFI P Gain]</i> in 0.5 unit increments.</li> </ul> <p><b>Note:</b> Set <i>n8-41 &gt; 0.0</i> for IPM motors.</p>
ov	Overvoltage	The deceleration time is too short and too much regenerative energy is flowing back into the drive.	<ul style="list-style-type: none"> <li>Set <i>L3-04 = 1 [Stall Prevention during Decel = General Purpose]</i>.</li> <li>Increase the values set in <i>C1-02, C1-04, C1-06, or C1-08 [Deceleration Times]</i>.</li> <li>Connect a dynamic braking option to the drive.</li> <li>Perform Deceleration Rate Tuning.</li> </ul>
		The acceleration time is too short.	<ul style="list-style-type: none"> <li>Make sure that sudden drive acceleration does not cause the fault.</li> <li>Increase the values set in <i>C1-01, C1-03, C1-05, or C1-07 [Acceleration Times]</i>.</li> <li>Increase the value set in <i>C2-02 [S-Curve Time @ End of Accel]</i>.</li> <li>Set <i>L3-11 = 1 [Overvoltage Suppression Select = Enabled]</i>.</li> </ul>
		The braking load is too large.	Connect a dynamic braking option to the drive.
		There are surge voltages in the input power supply.	Connect a DC link choke to the drive.  <b>Note:</b> If you turn the phase advancing capacitors ON and OFF and use thyristor converters in the same power supply system, there can be surge voltages that irregularly increase the input voltage.
		The drive output cable or motor is shorted to ground (the current short to ground is charging the main circuit capacitor of the drive through the power supply).	<ol style="list-style-type: none"> <li>Examine the motor main circuit cable, terminals, and motor terminal box, and then remove ground faults.</li> <li>Re-energize the drive.</li> </ol>
		If the drive detects <i>ov</i> in these conditions, the speed search-related parameters are incorrect: <ul style="list-style-type: none"> <li>During speed search</li> <li>During momentary power loss recovery</li> <li>When the drive starts again automatically</li> <li>When you use a premium efficiency motor</li> </ul>	<ul style="list-style-type: none"> <li>Examine the settings for all speed search related parameters.</li> <li>Set <i>b3-19 ≠ 0 [Speed Search Restart Attempts ≠ 0 times]</i>.</li> <li>Adjust <i>b3-03 [Speed Search Deceleration Time]</i>.</li> <li>Do Stationary Auto-Tuning for Line-to-Line Resistance and then set <i>b3-24 = 1 [Speed Search Method Selection = Speed Estimation]</i>.</li> <li>Use these values to adjust the parameters. <ul style="list-style-type: none"> <li><i>b3-03 [Speed Search Deceleration Time]</i> = default value × 2</li> <li><i>L2-03 [Minimum Baseblock Time]</i> = default value × 2</li> <li><i>L2-04 [Powerloss V/f Recovery Ramp Time]</i> = default value × 2</li> </ul> </li> </ul>
		The power supply voltage is too high.	Decrease the power supply voltage to match the drive rated voltage.

Code	Name	Causes	Possible Solutions
		The braking resistor or braking resistor unit wiring is incorrect.	Correct wiring errors in the connection to the braking resistor or braking resistor unit.
		The encoder cable is disconnected or wired incorrectly.	Examine for wiring errors or disconnected wires in the encoder cable, and repair problems.
		Noise interference along the encoder cable.	Isolate the encoder cable from the drive output line or a different source of electrical interference.
		Electrical interference caused a drive malfunction.	<ul style="list-style-type: none"> <li>Examine the control circuit lines, main circuit lines, and ground wiring, and decrease the effects of electrical interference.</li> <li>Make sure that a magnetic contactor is not the source of the electrical interference, then use a Surge Protective Device if necessary.</li> </ul>
		The load inertia is set incorrectly.	<ul style="list-style-type: none"> <li>Examine the load inertia settings with KEB, overvoltage suppression, or stall prevention during deceleration.</li> <li>Adjust L3-25 [Load Inertia Ratio] to match the qualities of the machine.</li> </ul>
		You used the Short Circuit Braking function when A1-02 = 5 [Control Method Selection = OLV/PM].	Connect a braking resistor to the drive.
		There is motor hunting.	<ul style="list-style-type: none"> <li>Adjust n1-02 [Hunting Prevention Gain Setting].</li> <li>Adjust n2-02 [Automatic Freq Regulator Time 1] and n2-03 [Automatic Freq Regulator Time 2].</li> <li>Adjust n8-45 [Speed Feedback Detection Gain] and n8-47 [Pull-in Current Comp Filter Time].</li> </ul>
		Speed Search at Start does not complete correctly when: <ul style="list-style-type: none"> <li>A1-02 = 8 [Control Method Selection = EZOLV]</li> <li>E9-01 = 0 [Motor Type Selection = Induction (IM)]</li> </ul>	Set b3-24 = 2 [Speed Search Method Selection = Current Detection 2].
PE1, PE2	PLC Faults	The communication option detected a fault.	Refer to the manual for the communication option card.
PF	Input Phase Loss	There is a phase loss in the drive input power.	Correct errors with the wiring for main circuit drive input power.
		There is loose wiring in the drive input power terminals.	Tighten the terminal screws to the correct tightening torque.
		The drive input power voltage is changing too much.	<ul style="list-style-type: none"> <li>Examine the input power for problems.</li> <li>Make the drive input power stable.</li> <li>If the input power supply is good, examine the magnetic contactor on the main circuit side for problems.</li> </ul>
		There is unsatisfactory balance between voltage phases.	<ul style="list-style-type: none"> <li>Examine the input power for problems.</li> <li>Make the drive input power stable.</li> <li>Set L8-05 = 0 [Input Phase Loss Protection Sel = Disabled].</li> </ul>
		The main circuit capacitors have become unserviceable.	<ul style="list-style-type: none"> <li>Examine the capacitor maintenance time in monitor U4-05 [Capacitor Maintenance]. If U4-05 is more than 90%, replace the control board or the drive. For information about replacing the control board, contact Yaskawa or your nearest sales representative.</li> <li>If drive input power is correct and the fault stays, replace the control board or the drive. For information about replacing the control board, contact Yaskawa or your nearest sales representative.</li> </ul>
PGo	Encoder (PG) Feedback Loss	The encoder cable is disconnected or wired incorrectly.	Examine for wiring errors or disconnected wires in the encoder cable, and repair problems.
PGoH	Encoder (PG) Hardware Fault	The encoder cable is disconnected.	Connect any disconnected wires in the encoder cable.
rF	Braking Resistor Fault	The resistance of the dynamic braking option that is connected to the drive is too low.	Use a dynamic braking option that fits the model and duty rating of the drive.
rH	Braking Resistor Overheat	The deceleration time is too short and excessive regenerative energy is flowing back into the drive.	<ul style="list-style-type: none"> <li>Check the load level, deceleration time, and speed.</li> <li>Decrease the load.</li> <li>Increase the values set in C1-02, C1-04, C1-06, or C1-08 [Deceleration Times].</li> <li>Use a dynamic braking option that lets you use more power.</li> </ul>
		The duty cycle is too high.	Examine the duty cycle. <b>Note:</b> When L8-01 = 1 [3% ERF DB Resistor Protection = Enabled], the maximum braking duty cycle is 3%.
		The braking load is too heavy.	<ul style="list-style-type: none"> <li>Calculate the braking load and braking power again, and decrease the braking load.</li> <li>Use a braking resistor that improves braking power.</li> </ul>
		The braking resistor is not sufficient.	Use the braking resistor specifications to select a sufficient braking resistor.

Code	Name	Causes	Possible Solutions
rr	Dynamic Braking Transistor Fault	The drive control circuit is damaged.	<ul style="list-style-type: none"> <li>Re-energize the drive.</li> <li>If the fault stays, replace the control board or the drive. For information about replacing the control board, contact Yaskawa or your nearest sales representative.</li> </ul>
		There is a malfunction in the internal braking transistor of the drive.	
SC	Short Circuit/IGBT Failure	Overheating caused damage to the motor or the motor insulation is not satisfactory.	Measure the motor insulation resistance, and replace the motor if there is electrical conduction or unserviceable insulation.
SCF	Safety Circuit Fault	The safety circuit is broken.	Replace the control board or the drive. For information about replacing the control board, contact Yaskawa or your nearest sales representative.
SEr	Speed Search Retries Exceeded	The speed search-related parameters are set incorrectly.	<ul style="list-style-type: none"> <li>Decrease <i>b3-10</i> [<i>Speed Estimation Detection Gain</i>].</li> <li>Increase <i>b3-17</i> [<i>Speed Est Retry Current Level</i>].</li> <li>Increase <i>b3-18</i> [<i>Speed Est Retry Detection Time</i>].</li> <li>Do Auto-Tuning again.</li> </ul>
STPo	Motor Step-Out Detected	The motor code is set incorrectly for PM Control Methods.	<ul style="list-style-type: none"> <li>Set <i>E5-01</i> [<i>PM Motor Code Selection</i>] correctly as specified by the motor.</li> <li>For specialized motors, refer to the motor test report and set <i>E5-xx</i> correctly.</li> </ul>
SvE	Zero Servo Fault	The value set in the torque limit is too small.	Adjust torque limit-related parameters <i>L7-01</i> to <i>L7-04</i> .
TiM	Keypad Time Not Set	There is a battery in the keypad, but the date and time are not set.	Use the keypad to set the date and time.
UL3	Undertorque Detection 1	A fault occurred on the machine. Example: There is a broken pulley belt.	Examine the machine and remove the cause of the fault.
UL4	Undertorque Detection 2	A fault occurred on the machine. Example: There is a broken pulley belt.	Examine the machine and remove the cause of the fault.
UL5	Mechanical Weakening Detection 2	The drive detected undertorque as specified by the conditions for mechanical weakening detection set in <i>L6-08</i> [ <i>Mechanical Fatigue Detect Select</i> ].	Examine the machine for deterioration.
Uv1	DC Bus Undervoltage	There is a phase loss in the drive input power.	Correct errors with the wiring for main circuit drive input power.
Uv2	Control Power Undervoltage	The value set in <i>L2-02</i> [ <i>Power Loss Ride Through Time</i> ] increased and the momentary power loss recovery unit is not connected to the drive.	Connect the momentary power loss recovery unit to the drive.
Uv3	Soft Charge Answerback Fault	There is damage to the relay or contactor on the soft-charge bypass relay.	<ul style="list-style-type: none"> <li>Re-energize the drive.</li> <li>If the fault stays, replace the control board or the drive.</li> <li>Monitor <i>U4-06</i> [<i>PreChargeRelayMainte</i>] shows the performance life of the soft-charge bypass relay. If <i>U4-06</i> is more than 90%, replace the board or the drive. For information about replacing the control board, contact Yaskawa or your nearest sales representative.</li> </ul>
		Air inside the drive is too hot.	Decrease the ambient temperature of the drive.

## ◆ Minor Faults/Alarms

This section gives information about the causes and possible solutions when a minor fault or alarm occurs. Use the information in this table to remove the cause of the minor fault or alarm.

Code	Name	Causes	Possible Solutions
AEr	Station Address Setting Error	The node address for the communication option is not in the permitted setting range.	<ul style="list-style-type: none"> <li>For CC-Link communication, set <i>F6-10</i> [<i>CC-Link Node Address</i>] correctly.</li> <li>For MECHATROLINK communication, set <i>F6-20</i> [<i>MECHATROLINK Station Address</i>] correctly.</li> <li>For CANopen communication, set <i>F6-35</i> [<i>CANopen Node ID Selection</i>] correctly.</li> </ul>
bAT	Keypad Battery Low Voltage	The keypad battery voltage is low.	Replace the keypad battery.
bb	Baseblock	An external baseblock command was entered through one of the MFDI terminals Sx, and the drive output stopped as shown by an external baseblock command.	Examine the external sequence and timing of the baseblock command input.
bCE	Bluetooth Communication Error	The smartphone or tablet with DriveWizard Mobile installed is too far from the keypad.	Use the smartphone or tablet 10 m (32.8 ft.) or nearer to the keypad. <b>Note:</b> <i>bCE</i> can occur when the smartphone or tablet is 10 m (32.8 ft.) or nearer to the keypad depending on the specifications of the smartphone or tablet.
		Radio waves from a different device are causing interference with communications between the smartphone or tablet and keypad.	Make sure that no device around the keypad uses the same radio bandwidth (2400 MHz to 2480 MHz), and prevent radio interference.

## 21 Troubleshooting

Code	Name	Causes	Possible Solutions
boL	Braking Transistor Overload	The duty cycle of the braking transistor is high (the regeneration power or repetition frequency is high).	<ul style="list-style-type: none"> <li>Install a braking unit (CDBR series).</li> <li>Install a regenerative converter.</li> <li>Increase the deceleration time.</li> </ul>
bUS	Option Communication Error	The communications cable wiring is incorrect.	Correct wiring errors.
CALL	Serial Comm Transmission Error	The communications cable wiring is incorrect.	Correct wiring errors.
		There is a short circuit in the communications cable or the communications cable is not connected.	<ul style="list-style-type: none"> <li>Repair the short-circuited or disconnected portion of the cable.</li> <li>Replace the defective communications cable.</li> </ul>
		A programming error occurred on the controller side.	Examine communications at start-up and correct programming errors.
		There is damage to the communications circuitry.	<ul style="list-style-type: none"> <li>Do a self-diagnostics check.</li> <li>If the problem continues, replace the control board or the drive. Contact Yaskawa or your nearest sales representative to replace the control board.</li> </ul>
		The termination resistor setting for MEMOBUS/Modbus communications is incorrect.	On the last drive in a MEMOBUS/Modbus network, set DIP switch S2 to the ON position to enable the termination resistor.
CE	Modbus Communication Error	The communications cable wiring is incorrect.	Correct wiring errors.
		There is a short circuit in the communications cable or the communications cable is not connected.	<ul style="list-style-type: none"> <li>Repair short circuits and connect cables.</li> <li>Replace the defective communications cable.</li> </ul>
		Electrical interference caused a communication data error.	<ul style="list-style-type: none"> <li>Examine the control circuit lines, main circuit lines, and ground wiring, and decrease the effects of electrical interference.</li> <li>Make sure that a magnetic contactor is not the source of the electrical interference, then use a Surge Protective Device if necessary.</li> <li>Use only the recommended cables or other shielded line. Ground the shield on the controller side or the drive input power side.</li> <li>Separate the communication wiring from drive power lines, and install a noise filter to the input side of the power supply for communication.</li> <li>Decrease the effects of electrical interference from the controller.</li> </ul>
		The communication protocol is not compatible.	<ul style="list-style-type: none"> <li>Examine the values set in H5-xx.</li> <li>Examine the settings on the controller side and correct the difference in communication conditions.</li> </ul>
		The value set in H5-09 [CE Detection Time] is too small for the communications cycle.	<ul style="list-style-type: none"> <li>Change the controller software settings.</li> <li>Increase the value set in H5-09.</li> </ul>
		The controller software or hardware is causing a communication problem.	Examine the controller and remove the cause of the problem.
CP1	Comparator 1 Limit Error	The monitor value set in H2-20 [Comparator 1 Monitor Selection] was in the range of H2-21 [Comparator 1 Lower Limit] and H2-22 [Comparator 1 Upper Limit].	Examine the monitor value and remove the cause of the error.
CP2	Comparator 2 Limit Error	The monitor value set in H2-26 [Comparator 2 Monitor Selection] was outside the range of H2-27 [Comparator 2 Lower Limit] and H2-28 [Comparator 2 Upper Limit].	Examine the monitor value and remove the cause of the error.
CrST	Cannot Reset	The drive received a fault reset command when a Run command was active.	Turn off the Run command then de-energize and re-energize the drive.
CyC	MECHATROLINK CommCycleSettingErr	The communications cycle setting of the controller is not in the permitted range of the MECHATROLINK interface option.	Set the communications cycle of the controller in the permitted range of the MECHATROLINK interface option.
dEv	Speed Deviation	The load is too heavy	Decrease the load.
dnE	Drive Disabled	A terminal set for H1-xx = 6A [Drive Enable] turned OFF.	Examine the operation sequence.
dWAL	DriveWorksEZ Alarm	There was an error in the DriveWorksEZ program.	Examine the DriveWorksEZ program and remove the cause of the error. This is not a drive fault.
dWA2	DriveWorksEZ Alarm 2	There was an error in the DriveWorksEZ program.	Examine the DriveWorksEZ program and remove the cause of the error. This is not a drive fault.
dWA3	DriveWorksEZ Alarm 3	There was an error in the DriveWorksEZ program.	Examine the DriveWorksEZ program and remove the cause of the error. This is not a drive fault.
E5	MECHATROLINK Watchdog Timer Err	The drive detected a watchdog circuit exception while it received data from the controller.	<p>Examine the MECHATROLINK cable connection. If this error occurs frequently, examine the wiring and decrease the effects of electrical interference as specified by these manuals:</p> <ul style="list-style-type: none"> <li>MECHATROLINK-II Installation Guide (MECHATROLINK Members Association, manual number MMATDEP011)</li> <li>MECHATROLINK-III Installation Manual (MECHATROLINK Members Association, publication number MMATDEP018)</li> </ul>

Code	Name	Causes	Possible Solutions
EF	FWD/REV Run Command Input Error	A forward command and a reverse command were input at the same time for longer than 0.5 s.	Examine the forward and reverse command sequence and correct the problem.
EF0	Option Card External Fault	The communication option card received an external fault from the controller.	<ol style="list-style-type: none"> <li>Find the device that caused the external fault and remove the cause.</li> <li>Clear the external fault input from the controller.</li> </ol>
EF1	External Fault (Terminal S1)	MFDI terminal S1 caused an external fault through an external device.	<ol style="list-style-type: none"> <li>Find the device that caused the external fault and remove the cause.</li> <li>Clear the external fault input in the MFDI.</li> </ol>
		The wiring is incorrect.	Correctly connect the signal line to MFDI terminal S1.
		<i>External Fault [H1-01 = 2C to 2F]</i> is set to MFDI terminal S1, but the terminal is not in use.	Correctly set the MFDI.
EF2	External Fault (Terminal S2)	MFDI terminal S2 caused an external fault through an external device.	<ol style="list-style-type: none"> <li>Find the device that caused the external fault and remove the cause.</li> <li>Clear the external fault input in the MFDI.</li> </ol>
		The wiring is incorrect.	Correctly connect the signal line to MFDI terminal S2.
		<i>External Fault [H1-02 = 2C to 2F]</i> is set to MFDI terminal S2, but the terminal is not in use.	Correctly set the MFDI.
EF3	External Fault (Terminal S3)	MFDI terminal S3 caused an external fault through an external device.	<ol style="list-style-type: none"> <li>Find the device that caused the external fault and remove the cause.</li> <li>Clear the external fault input in the MFDI.</li> </ol>
		The wiring is incorrect.	Correctly connect the signal line to MFDI terminal S3.
		<i>External Fault [H1-03 = 2C to 2F]</i> is set to MFDI terminal S3, but the terminal is not in use.	Correctly set the MFDI.
EF4	External Fault (Terminal S4)	MFDI terminal S4 caused an external fault through an external device.	<ol style="list-style-type: none"> <li>Find the device that caused the external fault and remove the cause.</li> <li>Clear the external fault input in the MFDI.</li> </ol>
		The wiring is incorrect.	Correctly connect the signal line to MFDI terminal S4.
		<i>External Fault [H1-04 = 2C to 2F]</i> is set to MFDI terminal S4, but the terminal is not in use.	Correctly set the MFDI.
EF5	External Fault (Terminal S5)	MFDI terminal S5 caused an external fault through an external device.	<ol style="list-style-type: none"> <li>Find the device that caused the external fault and remove the cause.</li> <li>Clear the external fault input in the MFDI.</li> </ol>
		The wiring is incorrect.	Correctly connect the signal line to MFDI terminal S5.
		<i>External Fault [H1-05 = 2C to 2F]</i> is set to MFDI terminal S5, but the terminal is not in use.	Correctly set the MFDI.
EF6	External Fault (Terminal S6)	MFDI terminal S6 caused an external fault through an external device.	<ol style="list-style-type: none"> <li>Find the device that caused the external fault and remove the cause.</li> <li>Clear the external fault input in the MFDI.</li> </ol>
		The wiring is incorrect.	Correctly connect the signal line to MFDI terminal S6.
		<i>External Fault [H1-06 = 2C to 2F]</i> is set to MFDI terminal S6, but the terminal is not in use.	Correctly set the MFDI.
EF7	External Fault (Terminal S7)	MFDI terminal S7 caused an external fault through an external device.	<ol style="list-style-type: none"> <li>Find the device that caused the external fault and remove the cause.</li> <li>Clear the external fault input in the MFDI.</li> </ol>
		The wiring is incorrect.	Correctly connect the signal line to MFDI terminal S7.
		<i>External Fault [H1-07 = 2C to 2F]</i> is set to MFDI terminal S7, but the terminal is not in use.	Correctly set the MFDI.
EF8	External Fault (Terminal S8)	MFDI terminal S8 caused an external fault through an external device.	<ol style="list-style-type: none"> <li>Find the device that caused the external fault and remove the cause.</li> <li>Clear the external fault input in the MFDI.</li> </ol>
		The wiring is incorrect.	Correctly connect the signal line to MFDI terminal S8.
		<i>External Fault [H1-08 = 2C to 2F]</i> is set to MFDI terminal S8, but the terminal is not in use.	Correctly set the MFDI.
EP24v	External Power 24V Supply	The voltage of the main circuit power supply decreased, and the 24 V power supply is supplying power to the drive.	<ul style="list-style-type: none"> <li>Examine the main circuit power supply.</li> <li>Turn ON the main circuit power supply to run the drive.</li> </ul>
FbH	Excessive PID Feedback	The <i>FbH</i> detection level is set incorrectly.	Adjust <i>b5-36 [PID High Feedback Detection Lvl]</i> and <i>b5-37 [PID High Feedback Detection Time]</i> .
		There is a problem with the PID feedback wiring.	Correct errors with the PID control wiring.

## 21 Troubleshooting

Code	Name	Causes	Possible Solutions
		The feedback sensor is not operating correctly.	Examine the sensors on the control device side.
		A fault occurred in the feedback input circuit of the drive.	Replace the control board or the drive. For information about replacing the control board, contact Yaskawa or your nearest sales representative.
FbL	PID Feedback Loss	The <i>FbL</i> detection level is set incorrectly.	Adjust <i>b5-13 [PID Feedback Loss Detection Lvl]</i> and <i>b5-14 [PID Feedback Loss Detection Time]</i> .
HCA	High Current Alarm	The load is too heavy.	<ul style="list-style-type: none"> <li>Decrease the load for applications with repetitive starts and stops.</li> <li>Replace the drive with a larger capacity model.</li> </ul>
L24v	Loss of External Power 24 Supply	The voltage of the backup 24 V power supply has decreased. The main circuit power supply is operating correctly.	<ul style="list-style-type: none"> <li>Examine the external 24 V power supply for disconnected wires and wiring errors and repair the problems.</li> <li>Examine the external 24 V power supply for problems.</li> </ul>
LoG	Com Error / Abnormal SD card	There is not a micro SD in the keypad.	Put a micro SD card in the keypad.
		<ul style="list-style-type: none"> <li>The drive is connected to USB.</li> <li>The number of log communication files is more than 1000.</li> <li>The micro SD card does not have available memory space.</li> <li>The line number data in a log communication file is not correct.</li> <li>A communication error between the keypad and drive occurred during a log communication.</li> </ul>	Set <i>o5-01 = 0 [Log Start/Stop Selection = OFF]</i> .
LT-1	Cooling Fan Maintenance Time	The cooling fan is at 90% of its expected performance life.	<ol style="list-style-type: none"> <li>Replace the cooling fan.</li> <li>Set <i>o4-03 = 0 [Fan Operation Time Setting = 0 h]</i> to reset the cooling fan operation time.</li> </ol>
LT-2	Capacitor Maintenance Time	The capacitors for the main circuit and control circuit are at 90% of expected performance life.	Replace the control board or the drive. For information about replacing the control board, contact Yaskawa or your nearest sales representative.
LT-3	SoftChargeBypassRelay MainteTime	The soft charge bypass relay is at 90% of its expected performance life.	Replace the control board or the drive. For information about replacing the control board, contact Yaskawa or your nearest sales representative.
LT-4	IGBT Maintenance Time (50%)	The IGBT is at 50% of its expected performance life.	Check the load, carrier frequency, and output frequency.
oH	Heatsink Overheat	The ambient temperature is high and the heatsink temperature is more than the <i>L8-02 [Overheat Alarm Level]</i> .	<ul style="list-style-type: none"> <li>Measure the ambient temperature.</li> <li>Increase the airflow around the drive.</li> <li>Install a cooling device (cooling fan or air conditioner) to lower the ambient temperature.</li> <li>Remove objects near the drive that are producing too much heat.</li> </ul>
oH2	External Overheat (H1-XX=B)	An external device sent an <i>oH2</i> .	<ol style="list-style-type: none"> <li>Find the external device that output the overheat alarm.</li> <li>Remove the cause of the problem.</li> <li>Clear the <i>Overheat Alarm (oH2) [H1-xx = B]</i> that was set to MFDI terminals S1 to S8.</li> </ol>
oH3	Motor Overheat (PTC Input)	The thermistor wiring that detects motor temperature is defective.	Correct wiring errors.
oL3	Overtorque 1	A fault occurred on the machine. Example: The machine is locked.	Examine the machine and remove the cause of the fault.
oL4	Overtorque 2	A fault occurred on the machine. Example: The machine is locked.	Examine the machine and remove the cause of the fault.
oL5	Mechanical Weakening Detection 1	The drive detected overtorque as specified by the conditions for mechanical weakening detection set in <i>L6-08 [Mechanical Fatigue Detect Select]</i> .	Do a deterioration diagnostic test on the machine side.
oS	Overspeed	There is overshoot.	<ul style="list-style-type: none"> <li>Decrease <i>C5-01 [ASR Proportional Gain 1]</i> and increase <i>C5-02 [ASR Integral Time 1]</i>.</li> <li>Use <i>H6-02 to H6-05 [Pulse Train Input Setting Parameters]</i> to adjust the pulse train gain.</li> </ul>
ov	Overvoltage	There are surge voltages in the input power supply.	Connect a DC link choke to the drive. <b>Note:</b> If you turn the phase advancing capacitors ON and OFF and use thyristor converters in the same power supply system, there can be surge voltages that irregularly increase the input voltage.
		The drive output cable or motor is shorted to ground. (The current short to ground is charging the main circuit capacitor of the drive through the power supply.)	<ol style="list-style-type: none"> <li>Examine the motor main circuit cable, terminals, and motor terminal box, and then remove ground faults.</li> <li>Re-energize the drive.</li> </ol>
		The power supply voltage is too high.	Decrease the power supply voltage to match the drive rated voltage.





Code	Name	Causes	Possible Solutions
		Electrical interference caused a drive malfunction.	<ul style="list-style-type: none"> <li>Examine the control circuit lines, main circuit lines, and ground wiring, and decrease the effects of electrical interference.</li> <li>Make sure that a magnetic contactor is not the source of the electrical interference, then use a Surge Protective Device if necessary.</li> <li>Set <math>L5-01 \neq 0</math> [Number of Auto-Restart Attempts <math>\neq 0</math> times].</li> </ul>
		The drive detects <i>ov</i> [Overvoltage] when: <ul style="list-style-type: none"> <li>The acceleration completes</li> <li>The deceleration starts</li> <li>The load changes suddenly</li> </ul>	<ul style="list-style-type: none"> <li>Increase the value set in <math>n2-03</math> [Automatic Freq Regulator Time 2] in 50 ms increments. <p><b>Note:</b> Make sure that you set <math>n2-02 \leq n2-03</math>. When you adjust <math>n2-03</math>, you must also increase the <math>C4-06</math> [Motor 2 Torque Comp Delay Time] value by same ratio.</p> </li> <li>Increase <math>C4-06</math> in 10 ms increments. <p><b>Note:</b> Make sure that you set <math>C4-02 \leq C4-06</math>. When you adjust <math>C4-06</math>, you must also increase the <math>n2-03</math> value by same ratio.</p> </li> </ul>
PASS	Modbus Communication Test	The MEMOBUS/Modbus communications test is complete.	The <i>PASS</i> display will turn off after communications test mode is cleared.
PF	Input Phase Loss	There is a phase loss in the drive input power.	Correct all wiring errors with the main circuit power supply.
		Loose wiring in the input power terminals.	Tighten the screws to the correct tightening torque.
		The drive input power voltage is changing too much.	<ul style="list-style-type: none"> <li>Examine the supply voltage for problems.</li> <li>Make the drive input power stable.</li> </ul>
		Unsatisfactory balance between voltage phases.	<ul style="list-style-type: none"> <li>Examine the supply voltage for problems.</li> <li>Make the drive input power stable.</li> <li>If the supply voltage is good, examine the magnetic contactor on the main circuit side for problems.</li> </ul>
		The main circuit capacitors have become unserviceable.	<ul style="list-style-type: none"> <li>Examine the capacitor maintenance time in monitor <math>U4-05</math> [Capacitor Maintenance].</li> <li>If <math>U4-05</math> is more than 90%, replace the capacitor. Contact Yaskawa or your nearest sales representative for more information.</li> <li>Examine the supply voltage for problems.</li> <li>Re-energize the drive.</li> <li>If the alarm stays, replace the circuit board or the drive. Contact Yaskawa or your nearest sales representative for more information.</li> </ul>
PGo	Encoder (PG) Feedback Loss	The encoder cable is disconnected or wired incorrectly.	Examine for wiring errors or disconnected wires in the encoder cable, and repair problems.
PGoH	Encoder (PG) Hardware Fault	The encoder cable is disconnected.	Correct any disconnected wires in the encoder cable.
rUn	Motor Switch during Run	The drive received a <i>Motor 2 Selection</i> [ $H1-xx = 16$ ] during run.	Make sure that the drive receives the Motor 2 Selection while the drive is stopped.
SE	Modbus Test Mode Error	MEMOBUS/Modbus communications self-diagnostics [ $H1-xx = 67$ ] was done while the drive was running.	Stop the drive and do MEMOBUS/Modbus communications self-diagnostics.
STo	Safe Torque OFF	Safe Disable inputs H1-HC and H2-HC are open.	<ul style="list-style-type: none"> <li>Make sure that the Safe Disable signal is input from an external source to terminal H1-HC and H2-HC.</li> <li>When the Safe Disable function is not in use, use a jumper to connect terminals H1-HC and H2-HC.</li> </ul>
		There is internal damage to the two Safe Disable channels.	Replace the board or the drive. Contact Yaskawa or your nearest sales representative to replace the board.
SToF	Safe Torque OFF Hardware	One of the two terminals H1-HC or H2-HC received the Safe Disable input signal.	<ul style="list-style-type: none"> <li>Make sure that the Safe Disable signal is input from an external source to terminals H1-HC or H2-HC.</li> <li>When the Safe Disable function is not in use, use a jumper to connect terminals H1-HC and H2-HC.</li> </ul>
		The Safe Disable input signal is wired incorrectly.	
		There is internal damage to one Safe Disable channel.	Replace the board or the drive. Contact Yaskawa or your nearest sales representative to replace the board.
TiM	Keypad Time Not Set	You put a battery in the keypad, but you have not set the date and time.	Set the date and time with the keypad.
TrPC	IGBT Maintenance Time (90%)	The IGBT is at 90% of its expected performance life.	Replace the IGBT or the drive. Contact Yaskawa or your nearest sales representative for more information.
UL3	Undertorque Detection 1	A fault occurred on the machine. Example: There is a broken pulley belt.	Examine the machine and remove the cause of the fault.
UL4	Undertorque Detection 2	A fault occurred on the machine. Example: There is a broken pulley belt.	Examine the machine and remove the cause of the fault.

Code	Name	Causes	Possible Solutions
UL5	Mechanical Weakening Detection 2	The drive detected undertorque as specified by the conditions for mechanical weakening detection set in L6-08 [Mechanical Fatigue Detect Select].	Examine the machine for deterioration.
Uv	Undervoltage	The drive input power voltage is changing too much.	<ul style="list-style-type: none"> <li>Examine the input power for problems.</li> <li>Make the drive input power stable.</li> <li>If the input power supply is good, examine the magnetic contactor on the main circuit side for problems.</li> </ul>

## ◆ Parameter Setting Errors

Parameter setting errors occur when multiple parameter settings do not agree, or when parameter setting values are not correct. Refer to the table in this section, examine the parameter setting that caused the error, and remove the cause of the error. You must first correct the parameter setting errors before you can operate the drive. The drive will not send notification signals for the faults and alarms when these parameter setting errors occur.

Code	Name	Causes	Possible Solutions
oPE01	Drive Capacity Setting Error	The value set in o2-04 [Drive Model (KVA) Selection] does not agree with the drive model.	Set o2-04 to the correct value.
oPE02	Parameter Range Setting Error	Parameter settings are not in the applicable setting range.	<ol style="list-style-type: none"> <li>Push  to show U1-18 [oPE Fault Parameter], and find parameters that are not in the applicable setting range.</li> <li>Correct the parameter settings.</li> </ol> <p><b>Note:</b></p> <ul style="list-style-type: none"> <li>If more than one error occurs at the same time, other oPExx errors have priority over oPE02.</li> </ul>
oPE03	Multi-Function Input Setting Err	The settings for these parameters do not agree: <ul style="list-style-type: none"> <li>F3-10 to F3-25 [Terminal D1 to DF Function Selection]</li> <li>H1-01 to H1-08 [Terminals S1 to S8 Function Selection]</li> <li>H7-01 to H7-04 [Virtual Multi-Function Inputs 1 to 4]</li> </ul>	Correct the parameter settings.
oPE05	Run Cmd/Freq Ref Source Sel Err	The setting to assign the Run command or frequency reference to an option card or the pulse train input is incorrect.	Correct the parameter settings.
oPE06	Control Method Selection Error	A1-02 = 1, 3, or 7 [Control Method Selection = CL-V/f, CLV, CLV/PM] is set, but there is no encoder option connected to the drive.	<ul style="list-style-type: none"> <li>Connect an encoder option to the drive.</li> <li>Set A1-02 correctly.</li> </ul>
oPE07	Analog Input Selection Error	The settings for H3-02, H3-06, and H3-10 [MFAI Function Select] and H7-30 [Virtual Analog Input Selection] overlap.	Set H3-02, H3-06, H3-10, and H7-30 correctly to prevent overlap. <p><b>Note:</b></p> It is possible to set these functions to multiple analog input terminals at the same time: <ul style="list-style-type: none"> <li>Setting value 0 [Frequency Reference]</li> <li>Setting values F and 1F [Not Used]</li> </ul>
oPE08	Parameter Selection Error	You set a function that is not compatible with the control method set in A1-02 [Control Method Selection].	<ol style="list-style-type: none"> <li>Push  to show U1-18 [oPE Fault Parameter], and find parameters that are not in the applicable setting range.</li> <li>Correct the parameter settings.</li> </ol> <p><b>Note:</b></p> If more than one error occurs at the same time, other oPExx errors have priority over oPE02.
		When A1-02 = 2 [Control Method Selection = OLV], you used these parameter settings: <ul style="list-style-type: none"> <li>n2-02 &gt; n2-03 [Automatic Freq Regulator Time 1 &gt; Automatic Freq Regulator Time 2]</li> <li>C4-02 &gt; C4-06 [Torque Compensation Delay Time &gt; Motor 2 Torque Comp Delay Time]</li> </ul>	<ul style="list-style-type: none"> <li>Set n2-02 &lt; n2-03.</li> <li>Set C4-02 &lt; C4-06.</li> </ul>
		When A1-02 = 0 [Control Method Selection = V/f], you used these parameter settings: <ul style="list-style-type: none"> <li>H6-01 = 3 [Terminal RP Pulse Train Function = Speed Feedback (V/F Control)]</li> <li>H1-xx = 16 [MFDI Function Select = Motor 2 Selection]</li> </ul>	Correct the parameter settings. <p><b>Note:</b></p> You cannot use Speed Feedback (V/F Control) with the Motor Switch function.
		When A1-02 = 5 [PM Open Loop Vector], you set E5-02 to E5-07 [PM Motor Parameters] = 0.	<ul style="list-style-type: none"> <li>Set E5-01 [PM Motor Code Selection] correctly as specified by the motor.</li> <li>For specialized motors, refer to the motor test report and set E5-xx correctly.</li> </ul>

Code	Name	Causes	Possible Solutions
		<p>When <math>A1-02 = 5</math> to <math>7</math> [<i>Control Methods for PM Motors</i>], you used these parameter settings:</p> <ul style="list-style-type: none"> <li><math>E5-09 = 0.0</math> [<i>PM Back-EMF <math>V_{peak}</math> (mV/(rad/s)) = 0.0 mV/(rad/s)</i>]</li> <li><math>E5-24 = 0.0</math> [<i>PM Back-EMF L-L <math>V_{rms}</math> (mV/rpm) = 0.0 mV/min<sup>-1</sup></i>]</li> </ul>	Set $E5-09$ or $E5-24$ to the correct value.
		When $A1-02 = 5$ to $7$ , you set $E5-09 \neq 0$ and $E5-24 \neq 0$ .	Set $E5-09 = 0$ or $E5-24 = 0$ .
		<p>When <math>A1-02 = 6</math> [<i>PM Advanced Open Loop Vector</i>], you used these parameter settings:</p> <ul style="list-style-type: none"> <li><math>n8-57 = 0</math> [<i>HFI Overlap Selection = Disabled</i>]</li> <li>You set <math>E1-09</math> [<i>Minimum Output Frequency</i>] &lt; the 5% value of <math>E1-06</math>.</li> </ul>	Correct the parameter settings.
		<p>When <math>A1-02 = 6</math>, you set these parameters:</p> <ul style="list-style-type: none"> <li><math>n8-35 = 0</math> [<i>Initial Pole Detection Method = Pull-in</i>]</li> <li><math>n8-57 = 1</math> [<i>Enabled</i>]</li> </ul>	Correct the parameter settings.
		<p>When <math>A1-02 = 8</math> [<i>EZOLV</i>], you used these parameter settings:</p> <ul style="list-style-type: none"> <li><math>E9-01 = 1, 2</math> [<i>Motor Type Selection = Permanent Magnet (PM), Synchronous Reluctance (SynRM)</i>]</li> <li><math>b3-24 = 2</math> [<i>Speed Search Method Selection = Current Detection 2</i>]</li> </ul>	When $E9-01 = 1$ or $2$ , set $b3-24 = 1$ [ <i>Speed Estimation</i> ].
oPE09	PID Control Selection Fault	<p>These parameters are set at the same time:</p> <ul style="list-style-type: none"> <li><math>b5-15 \neq 0.0</math> [<i>PID Sleep Function Start Level <math>\neq 0.0</math> Hz</i>]</li> <li><math>b1-03 = 2, 3</math> [<i>Stopping Method Selection = DC Injection Braking to Stop, Coast to Stop with Timer</i>]</li> </ul>	<ul style="list-style-type: none"> <li>Set <math>b5-15 \neq 0.0</math>.</li> <li>Set <math>b1-03 = 0, 1</math> [<i>Ramp to Stop, Coast to Stop</i>].</li> </ul>
		<p>These parameters are set at the same time:</p> <ul style="list-style-type: none"> <li><math>b5-01 = 1, 2</math> [<i>Enabled (Standard), Enabled (D = Feedforward)</i>]</li> <li><math>d2-02 \neq 0.0</math> [<i>Frequency Reference Lower Limit <math>\neq 0.0\%</math></i>]</li> <li><math>b5-11 = 1</math> [<i>PID Output Reverse Selection = Negative Output Accepted</i>]</li> </ul>	Correct the parameter settings.
		<p>These parameters are set at the same time:</p> <ul style="list-style-type: none"> <li><math>b5-01 = 3, 4</math> [<i>Trim (Fref+PID Out, D = Fdbk), Trim (Fref+PID Out, D = FeedFwd)</i>]</li> <li><math>d2-02 \neq 0.0</math> has been set.</li> </ul>	Correct the parameter settings.
oPE10	V/f Data Setting Error	<p>The parameters that set the V/f pattern do not satisfy these conditions:</p> <ul style="list-style-type: none"> <li>For motor 1: <math>E1-09 \leq E1-07 &lt; E1-06 \leq E1-11 \leq E1-04</math> [<i>Minimum Output Frequency <math>\leq</math> Mid Point A Frequency &lt; Base Frequency <math>\leq</math> Mid Point B Frequency <math>\leq</math> Maximum Output Frequency</i>]</li> <li>For motor 2: <math>E3-09 \leq E3-07 &lt; E3-06 \leq E3-11 \leq E3-04</math> [<i>Minimum Output Frequency <math>\leq</math> Mid Point B Frequency &lt; Base Frequency <math>\leq</math> Mid Point B Frequency <math>\leq</math> Maximum Output Frequency</i>]</li> </ul>	Set the parameters correctly to satisfy the conditions.
oPE11	Carrier Frequency Setting Error	<p>These parameters are set at the same time:</p> <ul style="list-style-type: none"> <li><math>C6-05 &gt; 6</math> [<i>Carrier Freq Proportional Gain &gt; 6</i>]</li> <li><math>C6-04 &gt; C6-03</math> [<i>Carrier Frequency Lower Limit &gt; Carrier Frequency Upper Limit</i>]</li> </ul> <p><b>Note:</b> When <math>C6-05 &lt; 7</math>, <math>C6-04</math> becomes disabled. The drive sets the carrier frequency to the value set to <math>C6-03</math>.</p>	Set $C6-02$ to $C6-05$ correctly.
		$C6-02$ to $C6-05$ settings are not in the applicable setting range.	
oPE13	Pulse Monitor Selection Error	$H6-06 = 101, 102, 105, \text{ or } 116$ [ <i>Terminal MP Monitor Selection = Frequency Reference, Output Frequency, Motor Speed, Output Frequency after Soft Starter</i> ] has not been set when $H6-07 = 0$ [ <i>Terminal MP Frequency Scaling = 0 Hz</i> ].	Set $H6-06$ correctly.
oPE15	Torque Control Setting Error	<p>More than one parameter is selecting torque control at the same time.</p> <ul style="list-style-type: none"> <li><math>d5-01 = 1</math> [<i>Torque Control Selection = Torque Control</i>]</li> <li><math>H1-xx = 71</math> [<i>MFDI Function Select = Torque Control</i>]</li> </ul>	Correct the parameter settings.

Code	Name	Causes	Possible Solutions
oPE16	Energy Saving Constants Error	The Energy Saving parameters are not set in the applicable setting range.	Make sure that <i>E5-xx</i> is set correctly as specified by the motor nameplate data.
oPE18	Online Tuning Param Setting Err	The parameters that control online tuning are set incorrectly. In OLV control, one of these parameters was set when <i>n6-01 = 2 [Online Tuning Selection = Voltage Correction Tuning]</i> : <ul style="list-style-type: none"> <li><i>E2-02 [Motor Rated Slip]</i> is set to 30% of the default setting or lower.</li> <li><i>E2-06 [Motor Leakage Inductance]</i> is set to 50% of the default setting or lower.</li> <li><i>E2-03 = 0 [Motor No-Load Current = 0 A]</i> has been set.</li> </ul>	Set <i>E2-02</i> , <i>E2-03</i> , and <i>E2-06</i> correctly.
oPE20	PG-F3 Setting Error	The value set in <i>F1-01 [Encoder 1 Pulse Count (PPR)]</i> does not agree with the number of encoder pulses.	<ul style="list-style-type: none"> <li>Examine the <i>F1-01</i> value and the number of encoder pulses.</li> <li>Set <i>F1-01</i> correctly.</li> </ul>
oPE33	Digital Output Selection Error	These two parameters are set at the same time: <ul style="list-style-type: none"> <li><i>H2-60 ≠ F [Term M1-M2 Secondary Function ≠ Not Used]</i></li> <li><i>H2-01 = 1xx [Term M1-M2 Function Selection = Inverse output of xx]</i></li> </ul>	Clear the <i>H2-01 to H2-03 = 1xx [Inverse output of xx]</i> settings. <b>Note:</b> It is not possible to set <i>H2-01 to H2-03 = 1xx [Inverse output of xx]</i> when using output functions for logic operations ( <i>H2-60</i> , <i>H2-63</i> , <i>H2-66 ≠ F</i> ).
		These two parameters are set at the same time: <ul style="list-style-type: none"> <li><i>H2-63 ≠ F [Term M3-M4 Secondary Function ≠ Not Used]</i></li> <li><i>H2-02 = 1xx [Term M3-M4 Function Selection = Inverse output of xx]</i></li> </ul>	
		These two parameters are set at the same time: <ul style="list-style-type: none"> <li><i>H2-66 ≠ F [Term M5-M6 Secondary Function ≠ Not Used]</i></li> <li><i>H2-03 = 1xx [Term M5-M6 Function Selection = Inverse output of xx]</i></li> </ul>	
		These parameter pairs are set incorrectly: <ul style="list-style-type: none"> <li><i>H2-21 [Comparator 1 Lower Limit] &gt; H2-22 [Comparator 1 Upper Limit]</i></li> <li><i>H2-27 [Comparator 2 Lower Limit] &gt; H2-28 [Comparator 2 Upper Limit]</i></li> </ul>	

### ◆ Auto-Tuning Errors

This table gives information about errors detected during Auto-Tuning. If the drive detects an Auto-Tuning error, the keypad will show the error and the motor will coast to stop. The drive will not send notification signals for faults and alarms when Auto-Tuning errors occur.

Two types of Auto-Tuning errors are: *Endx* and *Erx*. *Endx* identifies that Auto-Tuning has successfully completed with calculation errors. Find and repair the cause of the error and do Auto-Tuning again, or set the motor parameters manually. You can use the drive in the application if you cannot find the cause of the *Endx* error.

*Erx* identifies that Auto-Tuning was not successful. Find and repair the cause of the error and do Auto-Tuning again.

Code	Name	Causes	Possible Solutions
End1	Excessive Rated Voltage Setting	The torque reference was more than 20% during Auto-Tuning or the no-load current that was measured after Auto-Tuning is more than 80%.	<ul style="list-style-type: none"> <li>Make sure that the input motor nameplate data is correct.</li> <li>Do Auto-Tuning again and correctly set the motor nameplate data.</li> <li>If you can uncouple the motor and load, remove the motor from the machine and do Rotational Auto-Tuning again.</li> <li>If you cannot uncouple the motor and load, use the results from Auto-Tuning.</li> </ul>
End2	Iron Core Saturation Coefficient	The motor nameplate data entered during Auto-Tuning is incorrect.	<ul style="list-style-type: none"> <li>Make sure that the input motor nameplate data is correct.</li> <li>Do Auto-Tuning again and correctly set the motor nameplate data.</li> </ul>
End3	Rated Current Setting Alarm	The rated current value is incorrect.	Do Auto-Tuning again and set the correct rated current shown on the motor nameplate.
End4	Adjusted Slip Calculation Error	The Auto-Tuning results were not in the applicable parameter setting range.	<ul style="list-style-type: none"> <li>Make sure the input motor nameplate data is correct.</li> <li>Do Rotational Auto-Tuning again and correctly set the motor nameplate data.</li> <li>If you cannot uncouple the motor and load, do Stationary Auto-Tuning 2.</li> </ul>
End5	Resistance Tuning Error	The Auto-Tuning results of the Line-to-Line Resistance were not in the applicable range.	<ul style="list-style-type: none"> <li>Make sure that the input motor nameplate data is correct.</li> <li>Examine and repair damaged motor wiring.</li> </ul>

Code	Name	Causes	Possible Solutions
End6	Leakage Inductance Alarm	The Auto-Tuning results were not in the applicable parameter setting range.	Make sure that the input motor nameplate data is correct, and do Auto-Tuning again.
End7	No-Load Current Alarm	The Auto-Tuning results of the motor no-load current value were not in the applicable range.	Examine and repair damaged motor wiring.
End8	HFI Alarm	<ul style="list-style-type: none"> <li>Inductance saliency ratio (<i>E5-07/E5-06</i>) is too small.</li> <li>The drive cannot find the <i>n8-36</i> [<i>HFI Frequency Level for L Tuning</i>] value.</li> </ul>	<ul style="list-style-type: none"> <li>Set the correct value on the motor nameplate <i>E5-xx</i> [<i>PM motor parameters</i>] or do Stationary/Rotational Auto-Tuning, and then do High Frequency Injection Tuning again.</li> <li>When it is necessary to set <i>n8-35 = 1</i> [<i>Initial Pole Detection Method = High Frequency Injection</i>] or <i>n8-57 = 1</i> [<i>HFI Overlap Selection = Enabled</i>], make sure that there is no unusual noise in the low speed range (10% or less) and that the motor does not rotate in reverse at start. If there is unusual noise in the low speed range (10% or less), increase <i>n8-41</i> in increments of 0.5. Set <i>n8-41 &gt; 0.0</i> for IPM motors. <b>Note:</b> If the drive detects <i>End8</i>, it will automatically set <i>n8-35 = 0</i> [<i>Pull-in</i>] and <i>n8-57 = 0</i> [<i>Disabled</i>]. Do not change the settings unless necessary.</li> </ul>
End9	Initial Pole Detection Alarm	The drive cannot calculate the correct value for <i>n8-84</i> [ <i>Polarity Detection Current</i> ] during High Frequency Injection Tuning.	<ul style="list-style-type: none"> <li>Set the correct value on the motor nameplate <i>E5-xx</i> [<i>PM motor parameters</i>] or do Stationary/Rotational Auto-Tuning, and then do High Frequency Injection Tuning again.</li> <li>When <i>n8-35 = 1</i> [<i>Initial Pole Detection Method = High Frequency Injection</i>] or <i>n8-57 = 1</i> [<i>HFI Overlap Selection = Enabled</i>], make sure that the motor does not rotate in reverse at start. If there is unusual noise in the low speed range (10% or less), increase <i>n8-41</i> in increments of 0.5. Set <i>n8-41 &gt; 0.0</i> for IPM motors. <b>Note:</b> If the drive detects <i>End9</i>, it will automatically set <i>n8-35 = 0</i> [<i>Pull-in</i>] and <i>n8-57 = 0</i> [<i>Disabled</i>]. Do not change the settings unless necessary.</li> </ul>
Er-01	Motor Data Error	The motor nameplate data entered during Auto-Tuning is incorrect.	<ul style="list-style-type: none"> <li>Make sure that the motor nameplate data is correct.</li> <li>Do Auto-Tuning again and correctly set the motor nameplate data.</li> </ul>
Er-02	Drive in an Alarm State	The motor nameplate data entered during Auto-Tuning is incorrect.	<ul style="list-style-type: none"> <li>Make sure that the motor nameplate data entered in Auto-Tuning is correct.</li> <li>Do Auto-Tuning again and correctly set the motor nameplate data.</li> </ul>
Er-03	STOP Button was Pressed	During Auto-Tuning,  was pushed.	Auto-Tuning did not complete correctly. Do Auto-Tuning again.
Er-04	Line-to-Line Resistance Error	The Auto-Tuning results were not in the applicable parameter setting range.	<ul style="list-style-type: none"> <li>Examine and repair motor wiring.</li> <li>Disconnect the machine from the motor and do Rotational Auto-Tuning again.</li> </ul>
Er-05	No-Load Current Error	The Auto-Tuning results were not in the applicable parameter setting range.	<ul style="list-style-type: none"> <li>Examine and repair motor wiring.</li> <li>Disconnect the machine from the motor and do Rotational Auto-Tuning again.</li> </ul>
Er-08	Rated Slip Error	The motor nameplate data entered during Auto-Tuning is incorrect.	<ul style="list-style-type: none"> <li>Make sure that the input motor nameplate data is correct.</li> <li>Do Auto-Tuning again and correctly set the motor nameplate data.</li> </ul>
Er-09	Acceleration Error	The motor did not accelerate for the specified acceleration time.	<ol style="list-style-type: none"> <li>Increase the value set in <i>C1-01</i> [<i>Acceleration Time 1</i>].</li> <li>Disconnect the machine from the motor and do Rotational Auto-Tuning again.</li> </ol>
Er-10	Motor Direction Error	There is defective drive and motor wiring.	Examine and repair motor wiring.
Er-11	Motor Speed Error	The torque reference during acceleration is too high (100%).	<ul style="list-style-type: none"> <li>Increase the value set in <i>C1-01</i> [<i>Acceleration Time 1</i>].</li> <li>Disconnect the machine from the motor and do Rotational Auto-Tuning again.</li> </ul>
Er-12	Current Detection Error	There is a phase loss in the drive input power. (U/T1, V/T2, W/T3)	Examine and repair motor wiring.
Er-13	Leakage Inductance Alarm	The motor rated current value is incorrect.	Correctly set the rated current indicated on the motor nameplate and perform Auto-Tuning again.
		The drive could not complete tuning for leakage inductance in fewer than 300 seconds.	Examine and repair motor wiring.
Er-14	Motor Speed Error 2	The motor speed was more than two times the amplitude of speed reference during Inertia Tuning.	Decrease the value set in <i>C5-01</i> [ <i>ASR Proportional Gain 1</i> ].

Code	Name	Causes	Possible Solutions
Er-15	Torque Saturation Error	During Inertia Tuning, the output torque was more than the value set in L7-01 to L7-04 [Torque Limit].	<ul style="list-style-type: none"> <li>Increase the value set in L7-01 to L7-04 [Torque Limit] as much as possible.</li> <li>Decrease the values set for the frequency and amplitude of the test signals used when doing inertia tuning. First, decrease the test signal amplitude, and then do Inertia Tuning. If the error continues, decrease the test signal frequency and do Inertia Tuning again.</li> </ul>
Er-16	Inertia ID Error	The inertia found by the drive was too small or too large during Inertia Tuning (10% or less, or 50000% or more).	<ul style="list-style-type: none"> <li>Decrease the values set for the frequency and amplitude of the test signals used when doing inertia tuning. First, decrease the test signal amplitude, and then do Inertia Tuning. If the error continues, decrease the test signal frequency and do Inertia Tuning again.</li> <li>Correctly set the motor inertia as specified by the motor, and do Inertia Tuning again.</li> </ul>
Er-17	Reverse Prohibited Error	<p><i>b1-04 = 1 [Reverse Operation Selection = Reverse disabled]</i> has been set.</p> <p><b>Note:</b> You cannot do Inertia Tuning if the drive cannot rotate the motor in reverse.</p>	<ol style="list-style-type: none"> <li>Enable reverse in the target machine.</li> <li>Set <i>b1-04 = 0 [Reverse enabled]</i>.</li> <li>Do Inertia Tuning again.</li> </ol>
Er-18	Back EMF Error	The result of the induced voltage tuning was not in the applicable range.	<ol style="list-style-type: none"> <li>Make sure that the input motor nameplate data is correct.</li> <li>Do Auto-Tuning again and correctly set the motor nameplate data.</li> </ol>
Er-19	PM Inductance Error	The Auto-Tuning results of the PM motor inductance were not in the applicable range.	<ol style="list-style-type: none"> <li>Make sure that the input motor nameplate data is correct.</li> <li>Do Auto-Tuning again and correctly set the motor nameplate data.</li> </ol>
Er-20	Stator Resistance Error	The Auto-Tuning results of the PM Motor Stator Resistance were not in the applicable range.	<ol style="list-style-type: none"> <li>Make sure that the input motor nameplate data is correct.</li> <li>Do Auto-Tuning again and correctly set the motor nameplate data.</li> </ol>
Er-21	Z Pulse Correction Error	The motor is wired incorrectly.	1. Repair motor and encoder wiring errors.
		The encoder is wired incorrectly.	2. Do Z Pulse Offset Tuning again.
		You did Auto-Tuning on a coasting motor.	<ol style="list-style-type: none"> <li>Wait for the motor to fully stop.</li> <li>Do Z Pulse Offset Tuning again.</li> </ol>
		The setting for the direction of the encoder motor rotation is incorrect.	<ol style="list-style-type: none"> <li>Set the direction of motor rotation of the encoder in F1-05 [Encoder 1 Rotation Selection] correctly.</li> <li>Do Z Pulse Offset Tuning again.</li> </ol>
		The number of encoder pulses is incorrect.	<ol style="list-style-type: none"> <li>Set the number of encoder pulses in F1-01 [Encoder 1 Pulse Count (PPR)] correctly.</li> <li>Do Z Pulse Offset Tuning again.</li> </ol>
		The motor Inertia is too large.	Increase the value set in <i>n8-02 [Pole Alignment Current Level]</i> .
		Parameter <i>b1-04 = 1 [Reverse Operation Selection = Reverse Disabled]</i> and you did Z Pulse Offset Tuning.	<ul style="list-style-type: none"> <li>If the machine prevents reverse rotation, disconnect the motor from the machinery, set <i>b1-04 = 0 [Reverse Enabled]</i>, then do Z Pulse Offset Tuning. When tuning is complete, set <i>b1-04 = 1 [Reverse Disabled]</i>.</li> <li>If the machine does not prevent reverse rotation, set <i>b1-04 = 0</i> and do Z Pulse Offset Tuning.</li> </ul>
		The motor vibrates during tuning.	<ul style="list-style-type: none"> <li>Increase the values set in <i>n8-03 [Pole Position Detection Time]</i> and <i>n8-04 [Pole Alignment Time]</i>.</li> <li>Decrease the value set in <i>n8-02 [Pole Alignment Current Level]</i>.</li> </ul>
		The encoder is damaged.	<ul style="list-style-type: none"> <li>Examine the signal output from the encoder.</li> <li>Replace the encoder.</li> </ul>
Er-25	HighFreq Inject Param Tuning Err	The motor data is incorrect.	<p>Do Stationary Auto-Tuning again.</p> <p><b>Note:</b> If the drive detects <i>Er-25</i> after doing Stationary Auto-Tuning, the motor may not be able to use high frequency injection control. Contact Yaskawa or your nearest sales representative for more information.</p>

## ◆ Backup Function Operating Mode Display and Errors

### ■ Operating Mode Display

When you use the backup function from the LCD keypad, the keypad shows messages according to the current operation. These indicators do not show that an error has occurred.

Keypad Display	Name	Display	Status
Drive and Keypad mismatch. Should the parameters be restored?	Detection of inconsistency between the drive and keypad	Normally displayed	The drive detected the connection of a keypad from a different drive. Select [Yes] to copy parameters backed up in the keypad to the connected drive.
Restore Restore from keypad	Restoring parameters	Flashing	The parameters stored in the keypad have been restored to the drive.
End	Backup/restore/verify operation ended normally	Normally displayed	The parameter backup, restore, or verify operation ended normally.
Backup Backup from Drive	Backing up parameters	Flashing	The parameters stored in the drive are being backed up to the keypad.
Verify Keypad & Drive	Verifying parameters	Flashing	The parameter settings stored in the keypad and the parameter settings in the drive match or are being compared.

## ■ Backup Function Runtime Errors

When an error occurs, the keypad shows a code to identify the error.

The table in this section show the error codes. Refer to these tables to remove the cause of the errors.

### Note:

Push any key on the keypad to clear an error.

Code	Name	Causes	Possible Solutions
CPEr	Control Mode Mismatch	The keypad setting and drive setting for <i>A1-02 [Control Method Selection]</i> do not agree.	<ol style="list-style-type: none"> <li>Set <i>A1-02</i> on the drive to the same value that is on the keypad.</li> <li>Restore the parameters.</li> </ol>
CPyE	Error Writing Data	Parameter restore did not end correctly.	Restore the parameters.
CSEr	Control Mode Mismatch	The keypad is broken.	Replace the keypad.
dFPS	Drive Model Mismatch	You tried to restore parameters to a different drive model than the one that you backed up.	<ol style="list-style-type: none"> <li>Examine the drive model that you used to back up the parameters.</li> <li>Restore the parameters.</li> </ol>
iFEr	Keypad Communication Error	There was a communications error between the keypad and the drive.	Examine the connector or cable connection.
ndAT	Error Received Data	The parameter settings for model and specifications (power supply voltage and capacity) are different between the keypad and the drive.	<ol style="list-style-type: none"> <li>Make sure that drive model and the value set in <i>o2-04 [Drive Model (KVA) Selection]</i> agree.</li> <li>Restore the parameters.</li> </ol>
		The parameters are not stored in the keypad.	<ol style="list-style-type: none"> <li>Connect a keypad that has the correct parameters.</li> <li>Restore the parameters.</li> </ol>
PWEr	DWEZ Password Mismatch	The password set in the backup operation with <i>qx-xx [DriveWorksEZ Parameters]</i> and <i>rx-xx [DriveWorksEZ Connections]</i> is incorrect.	Set the DWEZ PC software password supplied by Yaskawa for the DWEZ program user ID downloaded to the drive.
rdEr	Error Reading Data	You tried to back up the data when <i>o3-02 = 0 [Copy Allowed Selection = Disabled]</i> .	Set <i>o3-02 = 1 [Enabled]</i> and back up again.
vAEr	Voltage Class, Capacity Mismatch	The power supply specifications or drive capacity parameter settings are different between the keypad and the drive.	<ol style="list-style-type: none"> <li>Make sure that drive model and the value set in <i>o2-04 [Drive Model (KVA) Selection]</i> agree.</li> <li>Restore the parameters.</li> </ol>
vFyE	Parameters do not Match	The parameters that are backed up in the keypad and the parameters in the drive are not the same.	<ol style="list-style-type: none"> <li>Restore or backup the parameter again.</li> <li>Verify the parameters.</li> </ol>

## Revision History

Date of Publication	Revision Number	Section	Revised Content
December 2022	2	All	Revision: Reviewed and corrected entire documentation
		17	Addition: Seismic Standards
		18	Addition: Australian Standard
May 2019	1	All	Revision: Reviewed and corrected entire documentation
		4, 5, 6, 12	Addition: Protection design added along with corresponding data. • IP55/UL Type 12 Heatsink External Mounting
August 2018	–	–	First Edition





# YASKAWA

## GA800 DRIVE INSTALLATION & PRIMARY OPERATION

### YASKAWA AMERICA, INC.

2121, Norman Drive South, Waukegan, IL  
60085, U.S.A.  
+1-800-YASKAWA (927-5292)  
[www.yaskawa.com](http://www.yaskawa.com)

### DRIVE CENTER (INVERTER PLANT)

2-13-1, Nishimiyaichi, Yukuhashi, Fukuoka,  
824-8511, Japan  
Phone: +81-930-25-2548  
[www.yaskawa.co.jp](http://www.yaskawa.co.jp)

### YASKAWA EUROPE GmbH

Hauptstraße 185, 65760 Eschborn, Germany  
Phone: +49-6196-569-300  
E-mail: [support@yaskawa.eu.com](mailto:support@yaskawa.eu.com)  
[www.yaskawa.eu.com](http://www.yaskawa.eu.com)

### YASKAWA ELÉTRICO DO BRASIL LTDA.

777, Avenida Piraporinha, Diadema, São  
Paulo, 09950-000, Brasil  
Phone: +55-11-3585-1100  
[www.yaskawa.com.br](http://www.yaskawa.com.br)

In the event that the end user of this product is to be the military and said product is to be employed in any weapons systems or the manufacture thereof, the export will fall under the relevant regulations as stipulated in the Foreign Exchange and Foreign Trade Regulations. Therefore, be sure to follow all procedures and submit all relevant documentation according to any and all rules, regulations and laws that may apply.

Specifications are subject to change without notice for ongoing product modifications and improvements.

Original instructions.

© 2018 YASKAWA Electric Corporation

YASKAWA ELECTRIC CORPORATION

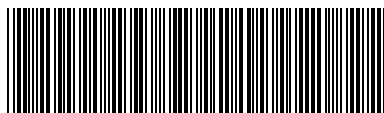

\*TOEPC71061737\*

TOEPC71061737  
Revision: C <2>-0  
December 2022  
Published in Japan  
22-12-24\_YAI